

# Operating Instructions

## Screw compressors with transmission drive and directly coupled screw compressors

Series  
S 76-4...S 160-4  
S 56-4 L...S 160-4 L  
S 56-4 LF...S 160-4 LF

Separate instructions:  
Compressor control  
Frequency converter (S LF)  
Compressed air treatment, accessories

[www.boge.com](http://www.boge.com)



---

# Operating instructions for screw compressors with transmission drive and for directly coupled screw compressors

- S 76-4 (75 kW)
- S 90-4 (90 kW)
- S 110-4 (110 kW)
- S 111-4 (110 kW)
- S 132-4 (132 kW)
- S 160-4 (160 kW)
- S 56-4 L (55 kW)
- S 110-4 L (110 kW)
- S 111-4 L (110 kW)
- S 132-4 L (132 kW)
- S 160-4 L (160 kW)
- S 56-4 LF (55 kW)
- S 76-4 LF (75 kW)
- S 90-4 LF (90 kW)
- S 110-4 LF (110 kW)
- S 111-4 LF (110 kW)
- S 132-4 LF (132 kW)
- S 160-4 LF (160 kW)



For safe and proper use, follow the contents of these instructions. Keep the instructions for future reference.

**BOGE KOMPRESSOREN**  
**Otto Boge GmbH & Co. KG**  
Postfach 10 07 13  
33507 Bielefeld

Otto-Boge-Straße 1-7  
33739 Bielefeld

Fon: +49 5206 601-0  
Fax: +49 5206 601-200  
Mail: [info@boge.com](mailto:info@boge.com)  
Net: [www.boge.com](http://www.boge.com)

**Original operating instructions**

Version: 02 / 2019

No. 596.1443.01

Nominal price: € 5.00



# Table of contents

<b>Part 1: About these instructions</b>	<b>1.1</b>	<b>Who are these instructions for?.....</b>	<b>1</b>	
	<b>1.2</b>	<b>Content of these instructions.....</b>	<b>1</b>	
	<b>1.3</b>	<b>Other important documents .....</b>	<b>2</b>	
	<b>1.4</b>	<b>Guide for reading.....</b>	<b>2</b>	
		Symbols and typographic aids.....	2	
		Structure of warning notices .....	3	
	<b>1.5</b>	<b>Warranty and service .....</b>	<b>4</b>	
	Limitation of liability.....	4		
	Damage during transport.....	4		
	Service / Technical Support.....	4		
	Data on the rating plate .....	5		
	<b>1.6</b>	<b>Systems subject to monitoring .....</b>	<b>5</b>	
<b>Part 2: Safety</b>	<b>2.1</b>	<b>General safety information .....</b>	<b>7</b>	
		Intended use.....	7	
		Reasonably foreseeable misuse.....	7	
		Responsibility of the operator .....	8	
		Personnel requirements.....	9	
		Special warning notices .....	10	
	<b>2.2</b>	<b>Safety information for operating the compressor .....</b>	<b>11</b>	
		Electrical equipment of the compressor.....	13	
		Compressor, drive, air system, oil circuit .....	13	
		Lubricant.....	14	
	<b>2.3</b>	<b>Servicing/maintenance safety information .....</b>	<b>15</b>	
	<b>Part 3: Product description</b>	<b>3.1</b>	<b>How the compressor works.....</b>	<b>17</b>
			Compression process in the airend .....	17
		Air system .....	17	
		Oil circuit.....	18	
		Air cooling.....	19	
		Water cooling.....	19	

<b>3.2</b>	<b>Control of the compressor</b> .....	<b>20</b>
	Net pressure .....	20
	Operating states .....	20
	Operating modes .....	20
	Frequency control .....	21
	Short operating periods .....	21
<b>3.3</b>	<b>Control devices</b> .....	<b>21</b>
	Operating pressure transmitter .....	21
<b>3.4</b>	<b>Safety and monitoring devices</b> .....	<b>22</b>
	Function of the safety and monitoring devices .....	22
	Triggering the emergency stop function using the Emergency Stop button (emergency shut-down).....	22
	Optional: Mains disconnecting device (main switch) .....	23
	Temperature monitoring by the control .....	23
	Decompression by means of the safety valve .....	23
	Monitoring of the drive and fan motor .....	24
	Rotational direction monitoring (option) .....	24
	Monitoring the maximum permissible system pressure .....	24
	Monitoring the system pressure build-up .....	24
<b>3.5</b>	<b>Technical data</b> .....	<b>25</b>
	S 76-4...S 160-4 (compressors with transmission drive), part 1 .....	25
	S 76-4...S 160-4 (compressors with transmission drive), part 2 .....	26
	S 56-4 L...S 160-4 L (directly coupled compressors), part 1 .....	27
	S 56-4 L...S 160-4 L (directly coupled compressors), part 2 .....	28
	S 56-4 LF...S 160-4 LF (directly coupled compressors, frequency-controlled), part 1 .....	29
	S 56-4 LF...S 160-4 LF (directly coupled compressors, frequency-controlled), part 2 .....	30
	Cooling water data .....	31
	Required cooling water quality.....	31
<b>3.6</b>	<b>Additional equipment</b> .....	<b>32</b>
	BOGE-Duotherm BPT .....	32
<b>4.1</b>	<b>Compressor transportation and storage</b> .....	<b>35</b>
	Safety information for transport .....	35
	Intermediate storage of the compressor before installation .....	35
	Transporting the compressor using a forklift truck .....	36
	Transporting the compressor with a crane .....	36
<b>4.2</b>	<b>Installing the compressor</b> .....	<b>37</b>
	Specifications for the operating area .....	37
	Ventilation of the compressor room .....	39
	Cooling air requirement .....	40
	Ventilation options .....	41

**Part 4:  
Installation**

	Checking the scope of the delivery.....	41
	Positioning the compressor and aligning it.....	42
	Removing transport lock from the drive (only available on S 111-4 to S 160-4 LF).....	42
	Removing the transport lock from the compressed air-oil receiver.....	43
	Checking the oil level.....	44
	Specifications for the installation of separate compressed air receivers.....	45
	Specifications for condensate disposal.....	45
	<b>4.3 Establishing the connections.....</b>	<b>46</b>
	Safety prior to commencing work.....	46
	Connecting the compressor to the compressed air network.....	47
	Connecting the water cooling (optional).....	48
	Establishing the electrical connection.....	48
	<b>4.4 Fitting additional compressor equipment.....</b>	<b>50</b>
	Fitting the super sound insulation (option).....	50
<b>Part 5: Commissioning</b>	<b>5.1 Commissioning the compressor.....</b>	<b>53</b>
	Safety prior to commencing work.....	53
	Checking installation conditions.....	54
	Checking the rotation direction of the drive and fan motors.....	55
	Checking the compressed air, oil and cooling water pipelines for leaks.....	56
	Opening the shut-off valves.....	57
	Conducting a test run.....	57
	Checking the pressure settings.....	57
	<b>5.2 Shutting down/recommissioning the compressor.....</b>	<b>58</b>
	Safety prior to commencing work.....	58
	Shutting down the compressor.....	58
	Intermediate storage of the compressor for prolonged periods.....	59
	Commissioning after a prolonged period of downtime: Adding oil.....	59
	<b>5.3 Dismantling.....</b>	<b>61</b>
<b>Part 6: Servicing and maintenance</b>	<b>6.1 Basic information on servicing/maintenance.....</b>	<b>63</b>
	The BOGE servicing concept.....	63
	Safety prior to commencing work.....	63
	Measures to be taken prior to maintenance work.....	64
	Measures to be taken following maintenance work.....	65
	Servicing by BOGE Service.....	65
	Overview of regular maintenance work.....	65
	Servicing intervals.....	66

	Maintenance work between (annual) servicing intervals .....	67
	Maintenance work at fixed servicing intervals .....	68
	General information on the lubricants used .....	70
	Disposal of used operating materials.....	70
	Spare and wearing parts.....	71
<b>6.2</b>	<b>Maintenance work between fixed servicing intervals .....</b>	<b>71</b>
	Weekly: Check/replace supply air filter mats .....	71
	Monthly: Clean/replace the suction filter.....	73
	Monthly: Check oil level, top up if needed .....	75
	Monthly: Clean the compressed air-oil cooler (air cooling).....	78
	Every 1,500 operating hours: Clean oil cooler (water cooling) .....	80
	Every 1,500 operating hours: Check pressure hoses for leaks/wear.....	80
<b>6.3</b>	<b>Performing maintenance work at fixed servicing intervals .....</b>	<b>81</b>
	Every 3,000 operating hours/annually: Change oil filter .....	81
	Every 3,000/9,000 operating hours: Change oil .....	83
	Every 3,000/9,000 operating hours: Change oil separator .....	90
	Every 3,000 operating hours: Function check of the safety valve .....	94
<b>6.4</b>	<b>Performing special maintenance work .....</b>	<b>95</b>
	Flushing the oil circuit .....	95
	Manual relubrication system: Lubricate the drive motor bearings .....	95
	Automatic relubrication system (optional): Change grease cartridges .....	98
	Having the drive motor bearings replaced .....	100
<b>6.5</b>	<b>Dismantling and disposal of replaced parts .....</b>	<b>101</b>
<b>6.6</b>	<b>Spare parts and additional equipment .....</b>	<b>102</b>
	List of wearing parts (for servicing).....	102
	List of available additional equipment.....	102
<b>Part 7: Remedying faults</b>	<b>7.1 Basic information on remedying faults .....</b>	<b>103</b>
	Safety prior to commencing work .....	103
	Compressor faults.....	104



<b>Part 8: Appendix</b>	<b>8.1</b>	<b>Guidelines and standards .....</b>	<b>105</b>
	<b>8.2</b>	<b>Application of the Pressure Equipment Directive .....</b>	<b>105</b>
		Scope.....	105
		Classification and assessment of pressurised components .....	106
		Outcome of the assessment.....	106
		Installation in compressed air systems .....	106
	<b>8.3</b>	<b>Piping and instrumentation flow chart .....</b>	<b>107</b>
		Air-cooled version with all options .....	108
		Water-cooled version with all options .....	110
	<b>8.4</b>	<b>List of maintenance and service work.....</b>	<b>112</b>



## 1.1 Who are these instructions for?

These instructions are aimed at end customers of BOGE who have purchased a screw compressor and wish to operate it.

In addition to reading these instructions, the user must meet the following prerequisites in order to ensure professional operation of the compressor. S/he must:

- Have an understanding of the control and of the accompanying operating instructions.
- Have an understanding of the accompanying operating instructions for the additional components.
- Be classified as skilled personnel or trained personnel with technical background knowledge in the field of compressed air technology.

## 1.2 Content of these instructions

These operating instructions deal exclusively with the functionality and operation of a BOGE Type S-4 (L/LF) screw compressor.

The prerequisite for safe operation of the screw compressor is adherence to all of the stipulated safety information and directions for use. Personnel must therefore have carefully read and understood these operating instructions before carrying out any work. In addition, the accident prevention regulations applicable in the location where the compressor is used as well as the general safety regulations must be observed. The illustrations in these instructions are provided for basic understanding and may differ from the actual version of the product. No claims can be made on this basis.

The following content and work descriptions do not (or only to a limited extent) form part of these instructions:

- Work on the electrical installations, e.g. the electrical commissioning or repairs to the control.
- Work on the compressed air treatment components or on accessories.

Work on the electrical installations may only be carried out by an authorised and qualified electrician or BOGE Service personnel.

BOGE recommends having the control, compressor(s) and accessories set up and commissioned by BOGE Service personnel. Servicing and maintenance work on the compressor LF should also be carried out by BOGE Service personnel.

## 1.3 Other important documents

- Safety data sheets on lubricants
- Data sheets/documentation on the control and accessories

## 1.4 Guide for reading

### Symbols and typographic aids

Symbol	Meaning
	<p><b>Tips and additional information on optimum operation</b>            Tips and information that help you to use the compressor in an optimum manner are indicated by the symbol shown.</p>
<ul style="list-style-type: none"> <li>– Information 1</li> <li>– Information 2</li> <li>– Information 3</li> </ul>	<p><b>List</b>            Important information is listed clearly.</p>
<ul style="list-style-type: none"> <li>• Action</li> </ul>	<p><b>Directions for use I</b>            Directions for use with <b>one action</b> are indicated by the symbol shown.</p>
<ol style="list-style-type: none"> <li>1. Action 1</li> <li>2. Action 2</li> <li>3. Action 3</li> </ol>	<p><b>Directions for use II</b>            Directions for use <b>with several actions</b> are numbered and must be carried out in the specified sequence.</p>
<p>→ Result of action</p>	<p><b>Result</b>            The outcome that will follow an action is indicated by the arrow shown.</p>
<p>(1) (2) (3)</p>	<p><b>Figures</b>            Figures may be divided into areas. The individual areas are numbered.</p>

## Structure of warning notices

The warning notices in these instructions indicate dangers that may occur when carrying out certain tasks. They also indicate how a dangerous situation can be avoided. Warning notices follow a fixed structure which is described below.

### Signal words

The following signal words are used:

Signal word	Meaning
<b>DANGER</b>	Warns of a danger to persons that will imminently lead to serious injury or death.
<b>WARNING</b>	Warns of dangers to persons that could lead to serious injury or death.
<b>CAUTION</b>	Warns of dangers to persons that could lead to moderate or minor injuries.
<b>ATTENTION</b>	Warns of property damage.

### General warning sign

In addition to specific warning signs, the following general warning sign is used in this document:

Warning sign	Meaning
	Warns of a hazardous area.

### Warning notice design

Warning notices are a combination of signal words, warning signs and information. They are structured as follows:

	<p><b>SIGNAL WORD</b></p> <p>Type of danger</p> <p>Source of the danger and consequences if the warning notice is not observed.</p> <p>→ How to avoid the danger.</p>
---	---

## 1.5 Warranty and service

### Limitation of liability

The manufacturer accepts no liability for direct or consequential damages due to improper operation or servicing on the basis of the information contained in these instructions. The product must only be operated by persons who are familiar with the operating instructions and the product, as well as the national laws, ordinances and regulations on work, safety and accident prevention.

We do not accept any liability for personal injury or property damage caused by untrained persons, or by non-compliance with the regulations on work, safety and accident prevention.

No claims for the modification of products that have already been supplied may be made on the basis of the information, illustrations and descriptions in this manual.

The obligations agreed upon in the delivery contract, our general terms and conditions as well as the delivery terms and statutory regulations valid at the time of the contract conclusion are in force.

For your own safety, only use original spare parts and accessories. We do not assume any liability for the use of other products and any consequential damage.

- Check the delivery for damage during transport and completeness.
- Document defects and damage in writing immediately.
- Take photographs of damaged components.
- Then submit the written damage report.

### Damage during transport

BOGE accepts no liability for breakage or damage during transport. Please check the item immediately after delivery and make a complaint to the last carrier about any damage, even if the packaging is not damaged. In order to secure your claim for damages against the shipping company, we would advise you to temporarily leave the delivery items and packaging materials in the condition in which you found them when you identified the damage.

Please submit all other complaints to us within six days of receiving the delivery.

### Service / Technical Support

To avoid delays, always provide the following data for your compressor when submitting enquiries:

- Type
- Year of manufacture
- Machine number



Should you have any questions about this product, please contact  
Technical Support on:

**Telephone: +49 5206 601-140**

If you require Service assistance, please contact BOGE Service on:

**Telephone: +49 5206 601-100**

**Data on the rating plate**

Enter the technical data for your compressor from the rating plate or enclosed data sheet into the figure below. Should you have any queries, this ensures that you always have the most important information to hand.

	
Type	_____
Year of manufacture	_____
Maschine number	_____
Volume flow	_____ max. _____ m <sup>3</sup> /min
Final compression pressure	_____ bar
Motor speed	_____ min <sup>-1</sup>
Motor output	_____ kW
 Otto Boge Str. 1-7 D - 33739 Bielefeld www.boge.com	
Fon +49 (0)5206/601-0 Fax +49 (0)5206/601-200 info@boge.com	
<b>Made in Germany</b>	

Fig. 1.1: Data on the rating plate

## 1.6 Systems subject to monitoring

A compressor is often part of a pressure vessel system, which is subject to monitoring according to the BetrSichV (Ordinance on Industrial Safety and Health). A system subject to monitoring shall only be put into service for the first time or after significant modifications if an approved body or a competent person has inspected the system to ensure it is in proper working order with regards to its assembly, installation, the conditions of erection and safety, taking into consideration its intended mode of operation.

According to the BetrSichV, the compressed air system shall be subjected to recurrent inspections by an approved body or competent person.

The operator must determine the inspection intervals within six months of commissioning and come to an agreement with the approved inspection body. The recurrent inspections must be arranged within the specified time frame and documented by the operator.

Operators located outside the Federal Republic of Germany must observe the national regulations for the country in which the device is used.





## 2.1 General safety information

### Intended use

- BOGE compressors, including their additional equipment, are exclusively intended for the compression and treatment of air for industrial purposes. The air taken in must not contain any explosive or chemically unstable gases or vapours.
- The specified operating limits of the compressor may not be exceeded.
- Only operate the compressor within the permissible ambient conditions.
- BOGE compressors are designed for stationary operation. Ensure that they are only installed and operated in clean, dry rooms.
- Operating elements and the control are designed for operation by trained or qualified personnel.

### Reasonably foreseeable misuse

The compressor must be operated within the technical limits of use. Observe section “Technical data” on page 25. Non-observance of this data is deemed improper and poses a risk for the operational safety of the compressor and a danger to the operating personnel. Severe personal injury and/or property damage may result.

- Never direct the compressed air produced towards persons.  
Danger of death!
- Only use the compressed air produced as breathing air or allow it to come into contact with food if it has been treated beforehand.
- This BOGE compressor is not explosion-proof. Do not operate in explosive areas or potentially explosive atmospheres.
- Do not operate the compressor in rooms in which extreme dust, toxic or flammable vapours and gases may be produced.

The following is not permitted:

- Compressing fluids other than those mentioned under intended use or compressing fluids loaded with contaminants.
- Exceeding the final compression pressure indicated on the rating plate.
- Altering the safety devices and cladding or putting them out of operation.
- Removing or painting over signs and symbols on the compressor.
- Operation of the compressor by untrained or unauthorised persons.

## Responsibility of the operator

### Obligations of the operator

The operator is obliged to

- Operate the compressor only in a technically perfect, safe-to-operate condition
- Provide a device that automatically switches off the power supply in the event of a fault, to avoid injury from electric current
- Check the completeness and function of the emergency stop device(s) at regular intervals
- Carry out a workplace risk assessment in his area of responsibility and issue the ensuing operating instructions
- Name a person responsible for the safe operation of the machine and the coordination of all work performed on the machine
- Avoid stressful situations when operating the compressor by means of technological and organisational operations scheduling
- Ensure proper workplace lighting is provided at the control section of the compressor according to the local health and safety regulations
- Observe the safety data sheets for the hazardous substances used and make all information accessible to personnel in accordance with the safety data sheet
- Provide the compulsory personal protective equipment, instruct others on its use and check that it is being worn at regular intervals
- Determine the personnel responsible for various tasks on the machine
- Instruct the personnel on a regular basis regarding all obligations concerning the preservation of safety and order at the compressor site
- Develop safe technology for the potential dismantling of the construction, define responsibilities (work safety, supervision, workmanship), supervise dismantling work and check compliance with the established protective measures and instructions.

### Operation regulations

The compressor unit operator is responsible for ensuring that it is installed, operated and maintained properly. Operators of work equipment in the Federal Republic of Germany must adhere to the regulations and rules currently valid for the Industrial Employers' Liability Insurance and Accident Insurance associations and also the Ordinance on Industrial Safety and Health (BetrSichV).

When operating the compressor unit outside the Federal Republic of Germany, the accident prevention regulations of the country in which the compressor is being operated must be observed in addition to the information contained in these operating instructions. In the event that measures are required above and beyond the legal regulations specified in the Federal Republic of Germany or the information contained in these operating instructions, it is of utmost importance that these be carried out prior to commissioning the compressor unit.

**Personnel requirements****General**

Only personnel authorised by the operator of the compressor may work with or on the compressor. The personnel working on the compressor must observe all industrial safety regulations and operating instructions, successfully carry out their responsibilities and read and understand the operating instructions. Compulsory personal protective equipment must always be worn when working on the compressor.

Only persons who are able to carry out work correctly and reliably and who meet the following requirements may perform activities on the compressor:

- Only authorised specialists should be instructed to carry out assembly, installation, service and maintenance work on the compressor.
- Work on the electrical equipment may only be carried out by an authorised and qualified electrician. The electrical equipment must be disconnected from the mains and precautions taken to prevent it from being switched back on again.
- The compressor must be operated by trained personnel.

**Trained personnel**

Trained personnel are persons whom the operator has given detailed information about the tasks assigned to them and the possible dangers.

**Qualified personnel/specialist**

Skilled personnel are persons who are able to successfully carry out work assigned to them, recognise possible dangers independently and avoid injury to persons or damage to property due to their professional training, knowledge and experience as well as knowledge of the relevant regulations.

**Qualified electrician**

All work on the electrical system may only be carried out by a qualified electrician. Qualified electricians are individuals who are able to successfully carry out work assigned to them, recognise potential dangers independently and avoid injury to individuals or property due to their qualifications, knowledge and experience as well as their knowledge of the relevant regulations.

**Personal protective equipment (PPE)**

The following must be worn for all work carried out on the compressor:

- Protective clothing
- Slip-resistant safety shoes and
- Hearing protection, if applicable.

The following must be worn when carrying out special duties:

- A protective helmet (for transportation with lifting gear)
- Protective goggles (for work on pressurised parts/components)
- Chemical-resistant protective gloves (when handling lubricants)
- Cut and puncture-resistant protective gloves

Before starting work with operating materials (e.g. lubricating greases) without wearing chemical-resistant protective gloves, a skin protection cream must be applied. After finishing the work a skin care product must be applied.

## Special warning notices

To indicate particular dangers, the following warning symbols/pictograms are used alongside warning notices:

### Danger due to electric current



...warns of life-threatening dangers due to electric current.

Non-observance of the warning notice can cause serious or fatal injuries.

Activities that follow this warning notice may only be carried out by authorised and qualified electricians.

### Danger from hot surfaces and operating materials



...warns of dangers from hot surfaces and operating materials.

Non-observance of the warning notice can result in serious burns.

Activities that follow this warning notice may only be carried out by authorised and qualified personnel.

### Danger from automatic restart



...warns of dangers due to an automatic restart.

Non-observance of the warning notice can cause serious injuries due to moving parts.

Activities that follow this warning notice may only be carried out by authorised and qualified personnel.

### Danger from overpressure and sudden discharge of fluids



...warns of dangers from overpressure and sudden discharge of fluids.

Non-observance of the warning notice can cause serious injuries.

Activities that follow this warning notice may only be carried out by authorised and qualified personnel.

**Danger due to moving parts**

	<p>...warns of dangers due to moving parts with the consequence of body parts being crushed, cut, sliced off or drawn in.</p> <p>Non-observance of the warning notice can cause serious injuries due to moving parts.</p> <p>Activities that follow this warning notice may only be carried out by authorised and qualified personnel.</p>
---	--

**Danger due to hazardous or irritant substances**

	<p>...warns of dangers from hazardous or irritant substances.</p> <p>Non-observance of the warning notice can cause injuries to the skin, eyes and respiratory tract.</p> <p>Activities that follow this warning notice may only be carried out by authorised and qualified personnel.</p>
---	--

**Danger due to easily flammable substances and the emergence of oxidizing environmental conditions**

	<p>...warns of danger due to highly flammable substances and the emergence of oxidising environmental conditions.</p> <p>There is a risk of burns if the warning notice is not observed.</p> <p>Activities that follow this warning notice may only be carried out by authorised and qualified personnel.</p>
---	---

**2.2 Safety information for operating the compressor**

	<p><b>WARNING</b></p> <p><b>Danger of personal injury or property damage!</b></p> <p>Non-observance of the following safety information may lead to injuries and damage to the compressor.</p> <p>→ Also observe the generally valid safety and accident prevention regulations in addition to the information in these operating instructions.</p>
---	---

1. Ensure that no commissioning and maintenance work is undertaken on the compressor until these operating instructions are understood.
2. Only use the compressor for its intended purpose, as described in these operating instructions.

3. The operator must ensure that:
  - Only appropriately trained and authorised personnel work on this compressor
  - No persons work on this compressor whose ability to react is impaired due to the use of drugs, alcohol, medication, etc.
  - Operating, servicing and repair personnel are familiar with all safety information and that it is being observed
  - The compressor is only operated in a safe operating condition.
4. Any procedure which may compromise the safety of the compressor must be avoided.
5. When working on the compressor, compulsory personal protective equipment must be worn for protection against injuries from sharp corners or edges.
6. To avoid dangers from debris or parts lying around, the work area of the compressor must be kept clean and tidy at all times.
7. Always squat when working on components mounted at a low height, never stoop. When working on components mounted higher up, always stand up straight.
8. The limit value for the final compression pressure specified on the rating plate must not be exceeded.
9. Do not operate the compressor without the required protective and safety devices.  
The built-in safety devices must not be removed or shut down.  
Ensure that all safety cladding and doors are closed before commissioning the compressor and that they are not opened during operation.
10. Prior to starting any servicing or repair work, always shut down the compressor as described in the operating instructions before removing any safety claddings or safety devices. All claddings and safety devices must be reattached and closed immediately upon completion of the repair or maintenance work.
11. Only operate the compressor using the additional equipment (options) recommended or authorised by the manufacturer.
12. Only undertake modifications or conversions of the compressor in agreement with BOGE, taking all relevant safety regulations into consideration. The manufacturer accepts no liability for damages resulting from unauthorised modifications to the compressor.
13. Never operate the compressor when one or more parts (e.g. cable, plug) are damaged, it is not in perfect working order, or damage is detected or suspected.
14. Observe all safety and danger signs on the compressor!
15. The compressor contains pressure equipment that must be tested prior to commissioning and at regular intervals, in accordance with national regulations: compressed air-oil container, if necessary cooler/heat exchanger.
16. In order to avoid damage, special precautions must be taken when (re-) commissioning compressors with frequency control if the frequency converter has been disconnected from the power supply for a relatively long period of time (> 12 months). In such cases, please contact Technical Support.

## Electrical equipment of the compressor



### DANGER

#### Risk of electric shock!

Coming into contact with live parts inside the switch cabinet or where the electrical equipment is housed can be fatal.

- Never open the electrical equipment and switch cabinet during operation.
- Work on the electrical equipment may only be carried out by authorised and qualified electricians.
- Prior to all work:
  1. Disconnect all power infeeds using a mains disconnecting device.
  2. Take precautions to prevent them being switched back on again.
  3. Check that all system components are de-energised.
  4. Earth and short circuit.
  5. Cover or enclose adjacent live parts.
- Check the electrical equipment of the compressor at regular intervals for defects such as loose connections or scorched cables. Have any defects rectified immediately.
- Make sure to have all electrical systems and fixed electrical installations checked by a qualified electrician at least every four years. Any modifications carried out after inspection must conform to EN 60204-1.
- Check that all safety devices on the machine are functioning properly at regular intervals.
- Only use original fuses.
- Never touch the relay outputs and the I/O terminals. Dangerous voltage may still be present even when the machine is disconnected from the mains.

## Compressor, drive, air system, oil circuit



### WARNING

#### Danger from overpressure, e.g. due to sudden discharge of fluids or bursting of components!

In the event of damage, malfunctioning or incorrect use, fluids under high pressure can escape from pipes or individual components and cause severe injuries.

- Work on the system and components may only be carried out by skilled personnel.
- Wear PPE.
- Depressurise pressurised system components before working on them.
- It is forbidden to operate the compressor unit without suitable safety devices.
- Safety devices must not be removed or shut down.
- The maximum permitted operating limits must not be exceeded.

**WARNING****Risk of burns from hot surfaces and fluids!**

High temperatures are produced during the compression process. There is a risk of injury from touching hot surfaces or from hot fluids escaping.

- The compressor unit must not be operated without suitable safety devices, e.g. isolating protective equipment.
- The work may only be carried out by skilled personnel.
- Wear PPE.
- Before carrying out any work ensure that all hot components have cooled down to 50°C.

**WARNING****Risk of injury due to moving parts or sharp edges!**

Risk of injury due to moving parts or sharp edges that can cause body parts to become caught, jammed, cut off or crushed. Non-observance of the safety information can result in serious injuries.

Please note that the cooling fan will run for some time even after the compressor has been switched off. Risk of hands becoming caught in the rotating impeller of the cooling fan.

- The compressor unit must not be operated without suitable safety devices, e.g. isolating protective equipment.
- The work may only be carried out by skilled personnel.
- Wear PPE.
- A protective plate prevents you from reaching into the impeller of the cooling fan.
- Work on the coupling may only be carried out while the compressor is at a standstill. All covers, screw connections and safety devices must be refitted immediately after the work.

**Lubricant****WARNING****Risk of fire and warning of property damage!**

In the case of a lack of oil, if the oil temperature threshold is exceeded or if there is mechanical damage within the screw compressor, incidents of ignition or deflagration may occur.

- Note the ignition temperature/flashpoint of the lubricant.
- Note the viscosity and purity of the lubricant.
- Excessively high oil temperatures lead to undercutting of the minimum viscosity with resulting bearing damage and rotor wear.
- The lubricant injection temperature must be noted. If the lubricant is cooled too much, condensate may accrue in the oil.



	<p><b>CAUTION</b> <b>Risk of injury due to contact with hazardous substances, e.g. from inhalation!</b></p> <p>Lubricants pose a potential danger to health and the environment as a result of their content.</p> <ul style="list-style-type: none"><li>→ Avoid contact with skin and eyes.</li><li>→ Wear PPE.</li><li>→ Do not inhale vapours or mists.</li><li>→ Fire, naked flames and smoking are strictly prohibited when handling hazardous substances.</li><li>→ Observe the information on the relevant safety data sheets.</li></ul>
---	--

## 2.3 Servicing/maintenance safety information

	<p><b>CAUTION</b> <b>Risk of injury when using unsuitable materials and components!</b></p> <p>If original spare parts, lubricants and operating materials approved by BOGE are not used during repair or servicing, there is a risk of injury as a result of mechanical failure, or serious property damage.</p> <ul style="list-style-type: none"><li>→ Only use original spare parts, lubricants and operating materials approved by BOGE during repair or servicing.</li></ul>
--	--

	<p><b>DANGER</b> <b>Risk of electric shock!</b></p> <p>Coming into contact with live parts inside the switch cabinet or where the electrical equipment is housed can be fatal.</p> <ul style="list-style-type: none"><li>→ To avoid such dangers, the power supply of the compressor must be equipped with a mains disconnecting device. The mains disconnecting device must conform to EN 60204-1.</li></ul>
---	---

- Maintenance work may only be carried out by appropriately trained persons.
- Changes to settings, fault rectification or repair work may only be carried out by authorised and qualified personnel.

**Prior to maintenance or repair work:**

1. Switch off the compressor using the OFF button.
2. Press the Emergency Stop button.
3. Disconnect all power infeeds using a mains disconnecting device.
4. Take precautions to prevent them being switched back on again.
5. Check that all system components are de-energised.
6. Earth and short circuit.
7. Cover or enclose adjacent live parts.
8. Fix a warning sign to the control and fill in the name of the person who is authorised to switch the machine back on.

9. Disconnect the compressor from the compressed air network (depressurise or block pressurised pipes).
10. Exercise extreme caution during repair or maintenance work that requires the compressor to be operational. Ensure that persons stay away from the danger area.
11. Ensure that work on the electrical equipment of the compressor is only carried out by qualified electricians.
12. Work on live parts or devices is prohibited. Exceptions are governed by the appropriate regulations, e.g. DIN VDE 0105.
13. Prior to starting work on the electrical system the electricity supply must be switched off and precautions taken to prevent it from being switched back on again. All dismantled covers and safety devices must be refitted immediately after work is finished.
14. The operator must check the compressor daily for externally visible damage and defects and report any changes (including operational behaviour) immediately.
15. When the automatic restart (Auto-Restart) is activated, the compressor will start automatically following a power failure. Prerequisite: the net pressure is lower than the set switch-on pressure.

### 3.1 How the compressor works

#### Compression process in the airend

The airend works in accordance with the displacement principle. The male rotor, which is driven by an electric motor, and the female rotor turn within the housing.

Both rotors have screw-shaped profiles that interlock with one another without making contact. These, together with the housing wall, form chambers, which get progressively smaller in the direction of the air flow.

The turning of the rotors guides the air that has been drawn in into the chambers, where it is compressed to the final pressure.

Oil is constantly injected into the airend during compression. It is used for cooling, sealing and lubrication.

#### Air system

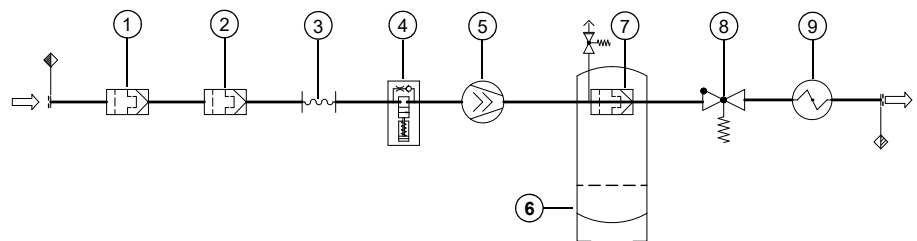

Fig. 3.1: Air system components

#### 1 Supply air filter (optional on S-4 (L)/standard on S-4 LF)

The supply air filter cleans the air drawn in from the airend.

#### 2 Suction filter

The suction filter cleans the air drawn in from the airend.

#### 3 Suction hose

#### 4 Suction regulator

The suction regulator opens (load-run) or closes (idle-run or standstill) the suction line depending on the operating state of the compressor.

#### 5 Airend

The airend compresses the air that has been drawn in.

#### 6 Compressed air-oil container

In the compressed air-oil container, the compressed air and oil are separated from one another by means of gravity.

#### 7 Oil separator

The oil separator separates the residual oil contained in the compressed air.

#### 8 Minimum pressure non-return valve

The minimum pressure non-return valve only opens once the system pressure has risen to 4.3 bar. This causes a rapid build-up of system pressure and ensures lubrication during the start-up phase. After the compressor has been switched off, the non-return valve prevents the compressed air from the network flowing back.

#### 9 Compressed air aftercooler (air- or water-cooled)

The compressed air is cooled down in the compressed air aftercooler. Here the water contained in the air condenses out.

## Oil circuit

The oil injected into the airend has the following tasks:

- Dissipating the compression heat (cooling).
- Sealing the gap between the rotors, and between the rotors and housing.
- Lubricating the bearings.

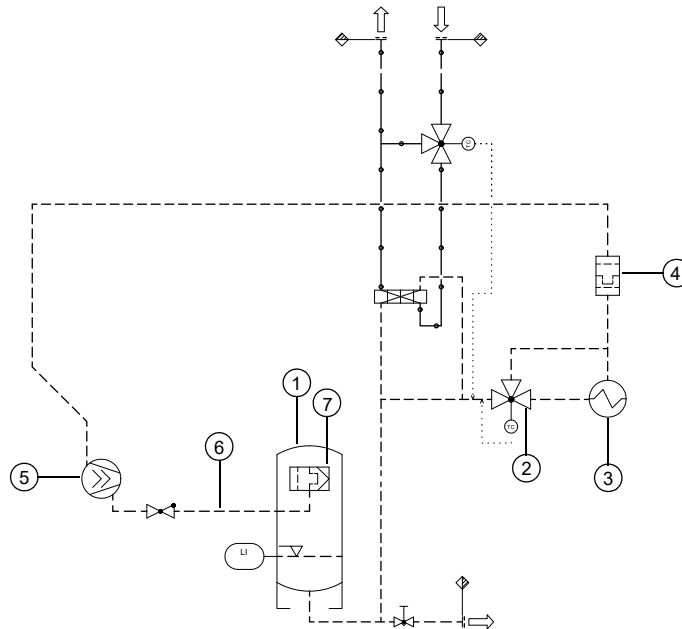

Fig. 3.2: Oil circuit components

### 1 Compressed air-oil container

The oil that has been separated from the compressed air by means of gravity collects in the compressed air-oil container. The system pressure presses this oil out of the container into the airend.

### 2 Thermostatic oil control valve

Depending on the oil temperature, the thermostatic oil control valve either directs the oil through the oil cooler or through a bypass (e.g. in the start-up phase).

This means that the oil always maintains its optimal operating temperature.

### 3 Oil cooler (air- or water-cooled)

The oil cooler cools the hot oil down to operating temperature.

### 4 Oil filter

The oil filter retains the dirt and impurities in the oil.

### 5 Airend

The injected oil returns to the compressed air-oil container with the compressed air. There it is separated by means of gravity.

### 6 Drainage line

Via the drainage line, the airend draws the residual oil that has collected in the oil separator back into the oil circuit.

### 7 Oil separator

The oil separator separates the residual oil contained in the compressed air.

## Air cooling

BOGE screw compressors are equipped with either air or water cooling. During air cooling, ambient air is fed into the machine interior by the radial fan and rotating motor. This cools the compressor system evenly by absorbing the heat generated from oil and compressed air (via the oil and compressed air aftercooler) and from heated components during the compression process. The heated air is then expelled upwards out of the cooling air outlet.



Information on the cooling air requirement and the minimum and maximum ambient/suction air temperature can be found in the technical data (page 25) and in the specifications for the compressor room (page 37).

## Water cooling

BOGE screw compressors are equipped with either air or water cooling. In the standard version of the water-cooled variant, the oil and compressed air aftercoolers are connected in series on the water side:

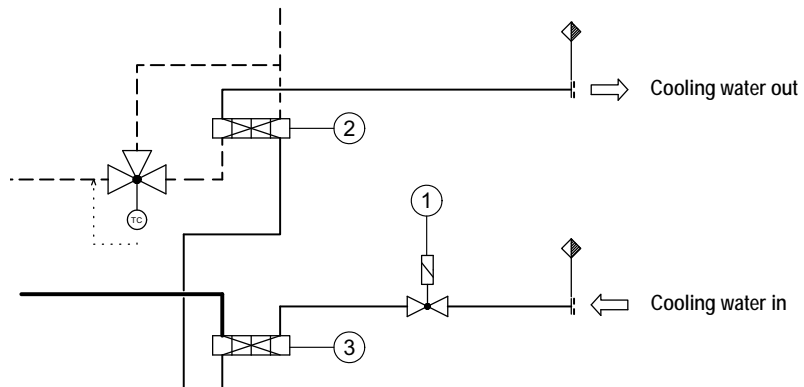

Fig. 3.3: Water cooling: Series connection

### 1 Cooling water solenoid valve

The cooling water solenoid valve closes off the cooling water supply when the compressor switches off.

### 2 Oil cooler

### 3 Compressed air aftercooler



The water coolers are designed for specific standard cooling water quantities, temperatures and pressures (see "Technical data", page 25). In the case of individual values that deviate from these, they are designed in accordance with the data specified in the order.

Also observe the cooling water data and the information on cooling water quality on page 31.

## 3.2 Control of the compressor

### Net pressure

In the compressor, the pressure behind the non-return valve is referred to as the net pressure. The control switches the compressor on and off during operation depending on the net pressure.

### Operating states

All control systems for compressors are based on three principal operating states:

#### 1. Load-run

- The compressor supplies the maximum amount of compressed air, based on its speed.
- To do so it consumes maximum power, based on its speed.

#### 2. Idle-run

- The compressor runs, but does not deliver any compressed air.
- It uses approximately 75% less energy than in load-run mode.
- If compressed air is required, it switches immediately to load-run.
- The idle-run mode cuts down the switching frequency that is harmful to the drive motor and reduces wear on the system.

#### 3. Standstill - ready for operation

- The compressor is stopped but ready for operation.
- If compressed air is required, it switches automatically to load-run.

### Operating modes

By combining the three operating states, the two most important operating modes are obtained:

#### 1. Intermittent mode

In intermittent mode the energy balance is optimal.

- The compressor is operated in load-run.
- The compressor switches to “Standstill - ready for operation” once the switch-off pressure ( $p_{\max}$ ) has been reached. It does not consume any power.
- Once the pressure has fallen to the switch-on pressure ( $p_{\min}$ ), it switches back to load-run.

#### 2. Continuous operation

Continuous operation cuts the number of drive motor switching cycles and reduces wear on the system.

- The compressor is operated in load-run.
- The compressor switches to idle-run once the switch-off pressure ( $p_{\max}$ ) has been reached.
- Once the pressure has fallen to the switch-on pressure ( $p_{\min}$ ), the compressor switches back from idle-run to load-run.

## Frequency control

If the switch-on pressure ( $p_{\min}$ ) is undercut, the compressor is started and works in load-run.

If the operating pressure ( $p_{\text{target}}$ ) is exceeded, the control function becomes active and reduces the speed.

If the operating pressure ( $p_{\text{target}}$ ) is undercut, the control function becomes active and increases the speed.

The compressor is switched to idle-run once the switch-off pressure ( $p_{\max}$ ) is reached.

The settings for switch-on pressure, switch-off pressure and operating pressure\* are specified through configuration of the compressor control.

\* see Delta p (FU) parameter

## Short operating periods



### ATTENTION

#### Risk of property damage!

With short operating periods, the compressor does not reach its operating temperature. It works below the dew point. The condensate that arises as a result mixes with the oil. The lubrication capacity of the oil is decreased. This leads to damage to the air end.

➔ In the event of short operating periods, please contact Technical Support or BOGE Service.

## 3.3 Control devices

### Operating pressure transmitter

The operating pressure transmitter (1) controls the operation of the compressor within the set pressure switching limits.

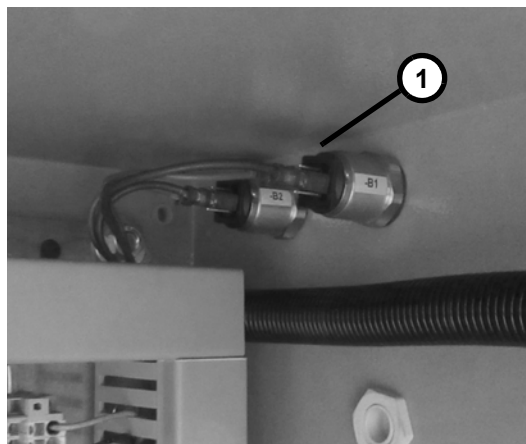

Fig. 3.4: Operating pressure transmitter

#### Switch-on pressure $p_{\min}$

If the net pressure falls to the set switch-on pressure ( $p_{\min}$ ), the compressor switches on.

#### Switch-off pressure $p_{\max}$

If the net pressure rises to the switch-off pressure ( $p_{\max}$ ), the compressor either switches off (intermittent mode) or to idle-run (continuous operation).

### 3.4 Safety and monitoring devices

#### Function of the safety and monitoring devices

The safety devices and BOGE monitoring system ensure a high level of operating safety.

The control reacts as follows in response to a safety device:

- The compressor is switched off immediately.
- A red cross at the top left of the control display indicates the fault.

	<p><b>CAUTION</b></p> <p><b>Risk of injury due to moving parts, thermal or pressure-related hazards!</b></p> <p>The uncontrolled operation of the compressor without any safety devices in place, with safety devices that are not functioning properly, or with safety devices removed, can lead to serious accidents involving the operating and service personnel.</p> <ul style="list-style-type: none"> <li>➔ Only operate the compressor with the safety devices installed.</li> <li>➔ The safety devices must not be removed or shut down.</li> </ul>
--	--

The following safety and monitoring devices are installed as standard or are optional:

#### Triggering the emergency stop function using the Emergency Stop button (emergency shut-down)

The emergency stop function serves to avoid an existing emergency situation or prevent an emergency situation arising due to the behaviour of persons or an unexpected event that implicates danger. The emergency stop function is provided by the emergency stop button control element. When the Emergency Stop button is pressed, compressor operation is stopped immediately, but the switch cabinet and control unit remain live.

The button is located in a prominent position under the control on the front of the compressor housing.

	<p><b>ATTENTION</b></p> <p><b>Compressor damage due to incorrect operation!</b></p> <p>Improper use of the Emergency Stop button, for example to switch off the compressor during normal operation, can damage or destroy the compressor.</p> <ul style="list-style-type: none"> <li>➔ Only use the emergency stop button to avoid/prevent an emergency situation.</li> <li>➔ During normal operation, the Off button should be pressed on the control to properly shut down the compressor.</li> </ul>
---	---



### Optional: Mains disconnecting device (main switch)

The mains disconnecting device is available as an option for compressors in this series. The mains disconnecting device is provided through the main switch.

When the main switch is pressed, compressor operation is stopped immediately and the switch cabinet and control are no longer live. Dangerous voltage may still be present in the relay outputs and the I/O terminals even when the machine is disconnected from the mains.

The main switch is located in a prominent position on the front of the compressor housing.



During normal operation, the Off button should be pressed on the control to properly shut down the compressor.

### Temperature monitoring by the control

#### The following temperature is monitored:

- Final compression temperature

The control switches the compressor off if the maximum permitted final compression temperature is reached. If the temperature is too low and the frost protection function is activated, the control allows the compressor to work in idle-run until the oil has reached an adequate operating temperature.

Only then is the compressor switched to load-run (prerequisite: the compressor must be in the “Standstill - ready for operation” operating state).

#### If the compressor needs to be switched off due to a fault:

1. Disconnect the compressor from the mains.
2. Remedy the fault.
3. Switch the compressor on again.
4. Acknowledge the fault (control).
5. Restore the compressor to an operational state (ON button / control).

### Decompression by means of the safety valve

A mechanical safety valve on the oil separation vessel prevents the maximum permitted pressure being exceeded.



#### WARNING

#### Risk of injury from flying parts caused by overpressure, e.g. pressurised components bursting or exploding!

A safety valve that has been removed or does not function properly means that the maximum permitted pressure in the compressor unit can no longer be limited. The uncontrolled pressure build up can cause severe injury to the operating and service personnel.

- ➔ The safety valve must not be removed or shut down.
- ➔ The specified final compression pressure must not be exceeded.
- ➔ Observe the statutory regulations applicable in the installation location for operating safety devices against overpressure.

	<p><b>CAUTION</b></p> <p><b>Risk of injury due to sudden discharge of hot compressed air!</b>  <b>Danger due to noise!</b></p> <p>If the maximum permitted pressure is exceeded (e.g. in the event of a fault or an incorrect setting), the entire free air delivery of the airend is blown off by the safety valve.</p> <p>→ The compressor should only be operated with the housing closed.</p>
---	---

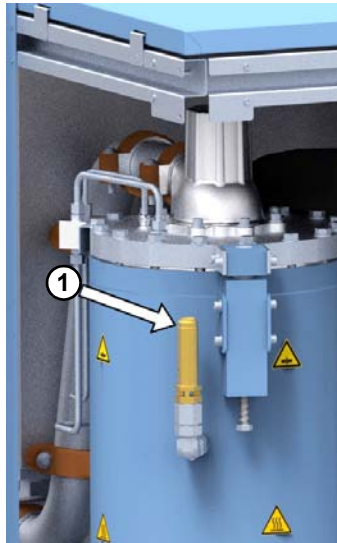

Fig. 3.5: Safety valve

The safety valve (1) on the oil separation vessel prevents the maximum permitted pressure from being exceeded.

### Monitoring of the drive and fan motor

The following monitoring devices are supplied as standard with the BOGE control unit:

The drive motor is monitored by a PTC thermistor.

The fan motor is monitored by an overcurrent release.

### Rotational direction monitoring (option)

At each start-up, the control checks the direction of rotation of the drive motor.

### Monitoring the maximum permissible system pressure

The control prevents the maximum permissible system pressure from being exceeded in accordance with the pressure settings. The switch-off pressure is below the pressure at which the safety valve responds.

### Monitoring the system pressure build-up

The control monitors the build-up of system pressure when starting the compressor.

### 3.5 Technical data

#### S 76-4...S 160-4 (compressors with transmission drive), part 1

Type		S 76-4	S 90-4	S 110-4	S 111-4	S 132-4	S 160-4	
<b>Dimensions</b>								
- Height (silenced)	[mm]	1,990	1,990	1,990	1,990	1,990	1,990	
- Height (super silenced)	[mm]	1,990	1,990	1,990	1,990	1,990	1,990	
- Width (silenced)	[mm]	2,330	2,330	2,330	2,930	2,930	2,930	
- Width (super silenced)	[mm]	2,330	2,330	2,330	2,930	2,930	2,930	
- Depth	[mm]	1,420	1,420	1,420	1,620	1,620	1,620	
<b>Weight (air-cooled)</b>								
- Silenced	[kg]	2,160	2,260	2,260	3,450	3,550	3,600	
- Super silenced	[kg]	2,180	2,280	2,280	3,500	3,600	3,650	
<b>Weight (water-cooled)</b>								
- Silenced	[kg]	2,100	2,200	2,200	3,200	3,350	3,400	
- Super silenced	[kg]	2,120	2,220	2,220	3,250	3,400	3,450	
Air cooling	Maximum sound pressure level in accordance with EN ISO 2151	[±3 dB(A)]						
	- Silenced/super silenced	[dB(A)]	73 / 70	75 / 73	77 / 75	70 / 67	70 / 67	74 / 73
	Enveloping surface dimension							
	- Silenced/super silenced	[dB(A)]	18 / 18	18 / 18	18 / 18	18 / 18	18 / 18	18 / 18
Water cooling	Maximum sound pressure level in accordance with EN ISO 2151	[±3 dB(A)]						
	- Silenced/super silenced	[dB(A)]	72 / 69	74 / 72	76 / 74	70 / 67	70 / 67	71 / 69
	Enveloping surface dimension							
	- Silenced/super silenced	[dB(A)]	18 / 18	18 / 18	18 / 18	18 / 18	18 / 18	18 / 18
Compressor	Sound power level							
	- Silenced/super silenced	[dB(A)]	91 / 88	93 / 91	95 / 93	88 / 85	88 / 85	92 / 91
	Max. final compression temperature	[°C]	110	110	110	110	110	110
	Volume flow in accordance with ISO 1217 at:							
- p <sub>max</sub> = 7.5 bar	[m <sup>3</sup> /min]	14.05	16.45	-	20.23	23.18	27.57	
- p <sub>max</sub> = 10 bar	[m <sup>3</sup> /min]	12.54	15.00	17.08	17.10	21.08	24.95	
- p <sub>max</sub> = 13 bar	[m <sup>3</sup> /min]	10.43	12.56	15.19	14.43	17.17	21.10	
<b>Drive motor</b>								
Rated power	[kW]	75	90	110	110	132	160	
Nominal speed								
- 50 Hz	[min <sup>-1</sup> ]	1,485	2,975* / 1,485**	2,975	1,490	1,490	1,490	
- 60 Hz	[min <sup>-1</sup> ]	1,785	3,575* / 1,785**	3,575	1,790	1,790	1,790	
Protection class	IP	55	55	55	55	55	55	
Design	IMB	35	35	35	35	35	35	
ISO class		F	F	F	F	F	F	
<b>Electrical Connection</b>								
Compressor supply voltage <sup>1)</sup>	[V]	400	400	400	400	400	400	
Frequency <sup>1)</sup>	[Hz]	50	50	50	50	50	50	
Recommended fuse at 400 V <sup>2) 3)</sup>	[A]	200	250	250	250	315	400	
<b>Alternative configuration (compressor)</b>								
Supply voltage/frequency	[V/Hz]	440 / 60	440 / 60	440 / 60	440 / 60	440 / 60	440 / 60	
Recommended fuse at 440 V <sup>2) 3)</sup>	[A]	160	200	250	250	250	355	

<sup>1)</sup> Basic configuration. Supply voltages and frequencies are detailed on a sign in the switch cabinet.

<sup>2)</sup> The fuse values change for different supply voltages.

<sup>3)</sup> Use gG fuses.

\* at 7.5 and 10 bar

\*\* at 13 bar

## S 76-4...S 160-4 (compressors with transmission drive), part 2

Type		S 76-4	S 90-4	S 110-4	S 111-4	S 132-4	S 160-4	
<b>Oil fill quantities</b>								
Oil receiver volume	[l]	140	140	140	177	177	177	
Total oil fill quantity	[l]	55	55	55	80	80	80	
max. oil refill quantity	[l]	10	10	10	10	10	10	
<b>Intake air temperature</b>								
- min.	[°C]	+ 5	+ 5	+ 5	+ 5	+ 5	+ 5	
- max.	[°C]	+ 46	+ 46	+ 46	+ 46	+ 46	+ 46	
<b>Air cooling</b>	Cooling air requirement							
	- Required cooling air flow for ventilation in accordance with VDMA 4363	[m³/h]	27,500	33,110	40,270	35,030	41,850	51,310
	- Cooling air requirement (air cooling and compressor intake)	[m³/h]	9,130	16,970	17,000	16,250	16,450	21,700
	- Free fan compression at max. fan speed	[Pa]	60	60	60	65	65	65
	- Free fan compression at max. fan speed	[mm WS]	6	6	6	6.6	6.6	6.6
<b>Water cooling - series connection</b>	Cooling air requirement							
	- Free-standing installation	[m³/h]	1,700	1,700	1,700	3,800	3,800	3,800
	Required cooling water quantity							
	- delta t = 15 K	[m³/h]	5.0	6.0	6.0	6.0	7.2	8.7
	- delta t = 30 K	[m³/h]	2.5	3.0	3.0	3.0	3.6	4.4
	Cooling water intake temperature							
- min.	[°C]	+ 5	+ 5	+ 5	+ 5	+ 5	+ 5	
- max.	[°C]	+ 30	+ 30	+ 30	+ 30	+ 30	+ 30	
Cooling water outlet temperature								
- max.	[°C]	+ 45	+ 45	+ 45	+ 45	+ 45	+ 45	
Cooling water pressure								
- min.	[bar]	2	2	2	2	2	2	
- max.	[bar]	10	10	10	10	10	10	
<b>Operating pressure transmitter <sup>1)</sup></b> (factory settings)								
- p <sub>max</sub> = 7.5 bar:	Switch-off pressure p <sub>max</sub>	[bar]	7.5	7.5	-	7.5	7.5	7.5
	Switch-on pressure p <sub>min</sub>	[bar]	6.5	6.5	-	6.5	6.5	6.5
- p <sub>max</sub> = 10 bar:	Switch-off pressure p <sub>max</sub>	[bar]	10	10	10	10	10	10
	Switch-on pressure p <sub>min</sub>	[bar]	9	9	9	9	9	9
- p <sub>max</sub> = 13 bar:	Switch-off pressure p <sub>max</sub>	[bar]	13	13	13	13	13	13
	Switch-on pressure p <sub>min</sub>	[bar]	12	12	12	12	12	12
<b>Safety valve</b>								
Response pressure at:								
- p <sub>max</sub> = 7.5 bar	[bar]	8.5	8.5	-	8.5	8.5	8.5	
- p <sub>max</sub> = 10 bar	[bar]	11	11	11	11	11	11	
- p <sub>max</sub> = 13 bar	[bar]	14	14	14	14	14	14	

<sup>1)</sup> For compressors for other operating pressures p<sub>min</sub> = p<sub>max</sub> - 1 bar.

**S 56-4 L...S 160-4 L (directly coupled compressors), part 1**

Type		S 56-4 L	S 110-4 L	S 111-4 L	S 132-4 L	S 160-4 L	
<b>Dimensions</b>							
- Height (silenced)	[mm]	1,990	1,990	1,990	1,990	1,990	
- Height (super silenced)	[mm]	1,990	1,990	1,990	1,990	1,990	
- Width (silenced)	[mm]	2,330	2,330	2,930	2,930	2,930	
- Width (super silenced)	[mm]	2,330	2,330	2,930	2,930	2,930	
- Depth	[mm]	1,420	1,420	1,620	1,620	1,620	
<b>Weight (air-cooled)</b>							
- Silenced	[kg]	2,070	2,170	3,450	3,550	3,600	
- Super silenced	[kg]	2,090	2,190	3,500	3,600	3,650	
<b>Weight (water-cooled)</b>							
- Silenced	[kg]	2,010	2,110	3,200	3,350	3,400	
- Super silenced	[kg]	2,030	2,130	3,250	3,400	3,450	
Air cooling	Maximum sound pressure level in accordance with EN ISO 2151	[±3 dB(A)]					
	- Silenced/super silenced	[dB(A)]	71 / 68	77 / 75	70 / 67	70 / 67	73 / 72
	Enveloping surface dimension						
	- Silenced/super silenced	[dB(A)]	18 / 18	18 / 18	18 / 18	18 / 18	18 / 18
Water cooling	Maximum sound pressure level in accordance with EN ISO 2151	[±3 dB(A)]					
	- Silenced/super silenced	[dB(A)]	70 / 67	76 / 74	70 / 67	70 / 67	70 / 67
	Enveloping surface dimension						
	- Silenced/super silenced	[dB(A)]	18 / 18	18 / 18	18 / 18	18 / 18	18 / 18
Compressor	Sound power level						
	- Silenced/super silenced	[dB(A)]	89 / 86	95 / 93	88 / 85	88 / 85	91 / 90
	Maximum sound pressure level in accordance with EN ISO 2151	[±3 dB(A)]					
	- Silenced/super silenced	[dB(A)]	70 / 67	76 / 74	70 / 67	70 / 67	70 / 67
Compressor	Enveloping surface dimension						
	- Silenced/super silenced	[dB(A)]	18 / 18	18 / 18	18 / 18	18 / 18	18 / 18
	Sound power level						
	- Silenced/super silenced	[dB(A)]	88 / 85	94 / 92	88 / 85	88 / 85	88 / 85
<b>Compressor</b>							
Max. final compression temperature	[°C]	110	110	110	110	110	
Volume flow in accordance with ISO 1217 at:							
- p <sub>max</sub> = 7.5 bar	[m <sup>3</sup> /min]	10.07	19.25	19.90	-	-	
- p <sub>max</sub> = 10 bar	[m <sup>3</sup> /min]	-	-	-	19.47	-	
- p <sub>max</sub> = 13 bar	[m <sup>3</sup> /min]	-	-	-	-	19.32	
<b>Drive motor</b>							
Rated power	[kW]	55	110	110	132	160	
Nominal speed							
- 50 Hz	[min <sup>-1</sup> ]	1,485	2,975	1,490	1,490	1,490	
- 60 Hz	[min <sup>-1</sup> ]	-	-	-	1,790	1,790	
Protection class							
Design	IP	55	55	55	55	55	
ISO class	IMB	35	35	35	35	35	
		F	F	F	F	F	
<b>Electrical Connection</b>							
Compressor supply voltage <sup>1)</sup>	[V]	400	400	400	400	400	
Frequency <sup>1)</sup>	[Hz]	50	50	50	50	50	
Recommended fuse at 400 V <sup>2) 3)</sup>	[A]	160	250	250	315	400	
<b>Alternative configuration (compressor)</b>							
Supply voltage/frequency	[V/Hz]	-	440 / 60	-	440 / 60	440 / 60	
Recommended fuse protection at 440 V <sup>2) 3)</sup>	[A]	-	250	-	250	355	

<sup>1)</sup> Basic configuration. Supply voltages and frequencies are detailed on a sign in the switch cabinet.

<sup>2)</sup> Different supply voltages alter the values for the fuse protection.

<sup>3)</sup> Use gG fuse cut-outs.

## S 56-4 L...S 160-4 L (directly coupled compressors), part 2

Type		S 56-4 L	S 110-4 L	S 111-4 L	S 132-4 L	S 160-4 L	
<b>Oil fill quantities</b>							
Oil receiver volume	[l]	140	140	177	177	177	
Total oil fill quantity	[l]	55	55	80	80	80	
max. oil refill quantity	[l]	10	10	10	10	10	
<b>Intake air temperature</b>							
- min.	[°C]	+ 5	+ 5	+ 5	+ 5	+ 5	
- max.	[°C]	+ 46	+ 46	+ 46	+ 46	+ 46	
Air cooling	Cooling air requirement						
	- Required cooling air flow for ventilation in accordance with VDMA 4363	[m³/h]	20,000	32,480	35,030	41,850	51,310
	- Cooling air requirement (air cooling and compressor intake)	[m³/h]	8,880	17,150	16,200	16,200	21,150
	- Free fan compression at max. fan speed	[Pa]	60	60	65	65	65
	- Free fan compression at max. fan speed	[mm WS]	6	6	6.6	6.6	6.6
Water cooling - series connection	Cooling air requirement						
	- Free-standing installation	[m³/h]	1,700	1,700	3,800	3,800	3,800
	Required cooling water quantity						
	- delta t = 15 K	[m³/h]	3.0	6.0	6.0	7.2	8.7
	- delta t = 30 K	[m³/h]	1.5	3.0	3.0	3.6	4.4
	Cooling water intake temperature						
	- min.	[°C]	+ 5	+ 5	+ 5	+ 5	+ 5
- max.	[°C]	+ 30	+ 30	+ 30	+ 30	+ 30	
Cooling water outlet temperature							
- max.	[°C]	+ 45	+ 45	+ 45	+ 45	+ 45	
Cooling water pressure							
- min.	[bar]	2	2	2	2	2	
- max.	[bar]	10	10	10	10	10	
<b>Operating pressure transmitter <sup>1)</sup> (factory settings)</b>							
- p <sub>max</sub> = 7.5 bar: Switch-off pressure p <sub>max</sub>	[bar]	7.5	7.5	7.5	-	-	
Switch-on pressure p <sub>min</sub>	[bar]	6.5	6.5	6.5	-	-	
- p <sub>max</sub> = 10 bar: Switch-off pressure p <sub>max</sub>	[bar]	-	-	-	10	-	
Switch-on pressure p <sub>min</sub>	[bar]	-	-	-	9	-	
- p <sub>max</sub> = 13 bar: Switch-off pressure p <sub>max</sub>	[bar]	-	-	-	-	13	
Switch-on pressure p <sub>min</sub>	[bar]	-	-	-	-	12	
<b>Safety valve</b>							
Response pressure at:							
- p <sub>max</sub> = 7.5 bar	[bar]	8.5	8.5	8.5	-	-	
- p <sub>max</sub> = 10 bar	[bar]	-	-	-	11	-	
- p <sub>max</sub> = 13 bar	[bar]	-	-	-	-	14	

<sup>1)</sup> For compressors for other operating pressures p<sub>min</sub> = p<sub>max</sub> - 1 bar.

**S 56-4 LF...S 160-4 LF (directly coupled compressors, frequency-controlled), part 1**

Type		S 56-4 LF	S 76-4 LF	S 90-4 LF	S 110-4 LF	S 111-4 LF	S 132-4 LF	S 160-4 LF	
<b>Dimensions</b>									
- Height (silenced)	[mm]	1,990	1,990	1,990	1,990	1,990	1,990	1,990	
- Height (super silenced)	[mm]	1,990	1,990	1,990	1,990	1,990	1,990	1,990	
- Width (silenced)	[mm]	2,330	2,330	2,330	2,330	2,980	2,980	2,980	
- Width (super silenced)	[mm]	2,330	2,330	2,330	2,330	2,980	2,980	2,980	
- Depth	[mm]	1,420	1,420	1,420	1,420	1,620	1,620	1,620	
<b>Weight (air-cooled)</b>									
- Silenced	[kg]	2,150	2,150	2,250	2,250	3,550	3,650	3,750	
- Super silenced	[kg]	2,170	2,170	2,270	2,270	3,600	3,700	3,800	
<b>Weight (water-cooled)</b>									
- Silenced	[kg]	2,090	2,090	2,190	2,190	3,350	3,450	3,500	
- Super silenced	[kg]	2,110	2,110	2,210	2,210	3,400	3,500	3,550	
Air cooling	Maximum sound pressure level in accordance with EN ISO 2151	[±3 dB(A)]							
	- Silenced/super silenced	[dB(A)]	71 / 68	72 / 69	74 / 72	77 / 75	70 / 67	70 / 67	74 / 73
	Enveloping surface dimension	[dB(A)]	18 / 18	18 / 18	18 / 18	18 / 18	18 / 18	18 / 18	18 / 18
Water cooling	Maximum sound pressure level in accordance with EN ISO 2151	[±3 dB(A)]							
	- Silenced/super silenced	[dB(A)]	70 / 67	71 / 68	73 / 71	76 / 74	70 / 67	70 / 67	71 / 69
	Enveloping surface dimension	[dB(A)]	18 / 18	18 / 18	18 / 18	18 / 18	18 / 18	18 / 18	18 / 18
Compressor	Sound power level	[dB(A)]	89 / 86	90 / 87	92 / 90	95 / 93	88 / 85	88 / 85	92 / 91
	- Silenced/super silenced	[dB(A)]	88 / 85	89 / 86	91 / 89	94 / 92	88 / 85	88 / 85	89 / 87
	Max. final compression temperature	[°C]	110	110	110	110	110	110	110
Volume flow in accordance with ISO 1217 at:									
- p <sub>max</sub> = 7.5 bar	[m <sup>3</sup> /min]	2.82...10.90	2.87...14.35	2.87...16.64	5.80...19.24	5.45...20.56	5.45...23.96	5.45...27.27	
- p <sub>max</sub> = 10 bar	[m <sup>3</sup> /min]	2.47...8.97	2.76...12.34	2.78...14.74	2.81...16.33	5.32...17.83	5.32...21.03	5.32...24.63	
- p <sub>max</sub> = 13 bar	[m <sup>3</sup> /min]	2.26...7.23	2.62...10.43	2.67...12.75	2.76...14.37	4.92...14.37	5.04...17.94	5.00...21.20	
<b>Drive motor</b>									
Rated power	[kW]	55	75	90	110	110	132	160	
Nominal speed									
- 50 Hz	[min <sup>-1</sup> ]	1,485	1,485	1,485	2,975 / 1,485*	1,490	1,490	1,490	
- 60 Hz	[min <sup>-1</sup> ]	1,785	1,785	1,785	3,575	1,790	1,790	1,790	
Protection class	IP	55	55	55	55	55	55	55	
Design	IMB	35	35	35	35	35	35	35	
ISO class	F	F	F	F	F	F	F	F	
<b>Electrical Connection</b>									
Compressor supply voltage <sup>1)</sup>	[V]	400	400	400	400	400	400	400	
Frequency <sup>1)</sup>	[Hz]	50	50	50	50	50	50	50	
Recommended fuse at 400 V <sup>2) 3)</sup>	[A]	125	160	200	250	250	315	400	
<b>Alternative configuration (compressor)</b>									
Supply voltage/frequency	[V/Hz]	440 / 60	440 / 60	440 / 60	440 / 60	440 / 60	440 / 60	440 / 60	
Recommended fuse at 440 V <sup>2) 3)</sup>	[A]	125	160	200	250	250	250	355	

<sup>1)</sup> Basic configuration. Supply voltages and frequencies are detailed on a sign in the switch cabinet.

<sup>2)</sup> The fuse values change for different supply voltages.

<sup>3)</sup> Use gG fuses.

\* on S 110-4 LF with 10/13 bar.

**S 56-4 LF...S 160-4 LF (directly coupled compressors, frequency-controlled), part 2**

Type		S 56-4 LF	S 76-4 LF	S 90-4 LF	S 110-4 LF	S 111-4 LF	S 132-4 LF	S 160-4 LF	
<b>Oil fill quantities</b>									
Oil receiver volume	[l]	140	140	140	140	177	177	177	
Total oil fill quantity	[l]	55	55	55	55	80	80	80	
max. oil refill quantity	[l]	10	10	10	10	10	10	10	
<b>Intake air temperature</b>									
- min.	[°C]	+ 5	+ 5	+ 5	+ 5	+ 5	+ 5	+ 5	
- max.	[°C]	+ 46	+ 46	+ 46	+ 46	+ 46	+ 46	+ 46	
<b>Air cooling</b>	Cooling air requirement								
	- Required cooling air flow for ventilation in accordance with VDMA 4363	[m³/h]	20,370	27,500	33,110	40,270	35,030	41,850	51,310
	- Cooling air requirement (air cooling and compressor intake)	[m³/h]	8,930	9,160	16,990	17,150	16,250	16,450	21,650
	- Free fan compression at max. fan speed	[Pa]	60	60	60	60	65	65	65
	- Free fan compression at max. fan speed	[mm WS]	6	6	6	6	6.6	6.6	6.6
<b>Water cooling - series connection</b>	Cooling air requirement								
	- Free-standing installation	[m³/h]	1,700	1,700	1,700	1,700	3,800	3,800	3,800
	Required cooling water quantity								
	- delta t = 15 K	[m³/h]	3.0	5.0	6.0	6.0	6.0	7.2	8.7
	- delta t = 30 K	[m³/h]	1.5	2.5	3.0	3.0	3.0	3.6	4.4
	Cooling water intake temperature								
	- min.	[°C]	+ 5	+ 5	+ 5	+ 5	+ 5	+ 5	+ 5
- max.	[°C]	+ 30	+ 30	+ 30	+ 30	+ 30	+ 30	+ 30	
Cooling water outlet temperature									
- max.	[°C]	+ 45	+ 45	+ 45	+ 45	+ 45	+ 45	+ 45	
Cooling water pressure									
- min.	[bar]	2	2	2	2	2	2	2	
- max.	[bar]	10	10	10	10	10	10	10	
<b>Operating pressure transmitter <sup>1)</sup> (factory settings)</b>									
- p <sub>max</sub> = 7.5 bar: Switch-off pressure p <sub>max</sub>	[bar]	7.5	7.5	7.5	7.5	7.5	7.5	7.5	
Switch-on pressure p <sub>min</sub>	[bar]	7	7	7	7	7	7	7	
- p <sub>max</sub> = 10 bar: Switch-off pressure p <sub>max</sub>	[bar]	10	10	10	10	10	10	10	
Switch-on pressure p <sub>min</sub>	[bar]	9.5	9.5	9.5	9.5	9.5	9.5	9.5	
- p <sub>max</sub> = 13 bar: Switch-off pressure p <sub>max</sub>	[bar]	13	13	13	13	13	13	13	
Switch-on pressure p <sub>min</sub>	[bar]	12.5	12.5	12.5	12.5	12.5	12.5	12.5	
<b>Safety valve</b>									
Response pressure at:									
- p <sub>max</sub> = 7.5 bar	[bar]	14	14	14	14	14	14	14	
- p <sub>max</sub> = 10 bar	[bar]	14	14	14	14	14	14	14	
- p <sub>max</sub> = 13 bar	[bar]	14	14	14	14	14	14	14	

<sup>1)</sup> For compressors for other operating pressures p<sub>min</sub> = p<sub>max</sub> - 0.5 bar.



**Cooling water data**

The compressor cooling water must meet the following requirements:

Electrical conductivity	– > 50 µS/cm at pH value 7 – 9
Carbonate hardness (CaCO <sub>3</sub> )	– < 15° dH
Total hardness	– < 21° dH
Cooling water pressure	– max. 10.0 bar – min. 2.0 bar
Cooling water inlet temperature	– min. + 5°C – max. + 30°C

For the maximum cooling water quantity, refer to “Technical data”.

**Required cooling water quality**

The coolers are equipped with plate heat exchangers as standard. In order to avoid damage to these components and for long-term operation, the contents of the cooling water used must not exceed the following values.

Content	Symbol	Max. permitted concentration [mg/l]
Ammonia	NH <sub>3</sub>	< 2.0
Chloride < 70°C	Cl	100
Free chlorine	Cl	< 0.5
Iron	Fe	< 0.2
Free aggressive carbon dioxide	CO <sub>2</sub>	< 20
Manganese	Mn	< 0.1
Nitrate	NO <sub>3</sub>	< 100
Oxygen	O <sub>2</sub>	< 2
Silicon oxide	SiO <sub>2</sub>	< 8
Sulphates	SO <sub>4</sub>	< 60
Total dissolved solids	TDS	< 30

*Table 3.1: Maximum permitted concentrations of contents*



If the specified limit values are exceeded, coolers made from other materials must be used.  
Please contact Technical Support.

**ATTENTION****Risk of property damage or malfunctions!**

Incorrectly-designed coolers may lead to malfunctions and switching off of the compressor.

➔ If the cooling water data change, it may be necessary to redesign the coolers. Please contact Technical Support.

## 3.6 Additional equipment

### BOGE-Duotherm BPT

#### Function

The **BOGE-Duotherm BPT** heat recovery system uses the thermal energy released during compression to generate hot water free of charge (e.g. for production devices or to supply a heating system).

The plate heat exchanger is connected in the main flow of the hot oil. It consists of two stainless steel plates that are soldered together. These form two duct systems that are closed off from one another. Compressor oil flows through the ducts in one direction, while water flows through them in the opposite direction. As it passes through, the hot oil transfers its heat to the colder water via the plates.

#### Assembly

In general, the plate heat exchanger has already been installed in the compressor and piped in the factory. During assembly, only the following work remains to be carried out:

1. Connect the water supply and outlet to the pipeline network.  
In doing so, lay the pipelines so that no tensions and vibrations are transferred to the heat exchanger.
2. Provide options for venting and drainage.

During assembly, the following components must be provided on site:

- Shut-off valves  
Shut-off valves in the water supply and outlet enable easy removal of the heat exchanger.
- Expansion vessel and safety valve.



#### ATTENTION

##### Risk of property damage!

Damage to the plate heat exchanger due to pressure increase.

If the shut-off valves in the water supply and outlet lines are closed at the same time, a sealed space is created. If the water in this space heats up, it expands, and the pressure increases.

➔ Install an expansion vessel and a safety valve.

- Dirt trap (pore width: max. 0.6 mm)  
If the water contains a high level of contamination, the dirt trap at the water inlet protects the plate heat exchanger from dirt accumulation.
- Flushing ports  
The flushing ports are used for cleaning the plate heat exchanger.

#### Separate installation

The plate heat exchanger can also be installed separately or retrofitted on site. Normally, the plate heat exchanger is held in place by the pipes. With larger models, it may be necessary to provide a console on site for support.

**Commissioning**

Proceed as follows for commissioning:

1. Check the oil level in the oil circuit. Top up the oil if necessary.
2. Slowly open the shut-off valves in the water supply and outlet.  
Avoid pressure shocks!
3. Vent the pipelines.

**Servicing**

Limescale, oxides and grease or oil deposits accumulate in the ducts of the plate heat exchanger during operation.

Regular cleaning prevents thick deposits blocking individual ducts of the plate heat exchanger.

**– Cleaning intervals**

- Heavily-contaminated or hard water: 6 months
- Moderately-contaminated water, surface water: 1 year
- Water with a low level of contamination: 3 years

**– Recommended cleaning agents**

Grease or oil deposits: paraffin

Oxide or limescale deposits: formic acid, acetic acid, citric acid.

**ATTENTION**

Risk of property damage!

If cleaning agents are used incorrectly, components may be damaged.

➔ Ensure that you observe the instructions of the cleaning agent manufacturer when using the product.

**Prerequisites for maintenance work**

- The compressor has been switched off using the OFF button.
- The compressor has been vented and the system pressure display shows 0 bar.
- The Emergency Stop button has been pressed, the mains disconnecting device has been opened (or the optional main switch has been pressed) and it has been secured with a padlock to prevent it from being accidentally switched on again.
- It has been checked that no voltage is present.
- All hot components have cooled down.
- The compressor has been disconnected from the compressed air network.
- The oil has settled.

**Cleaning methods**

Flushing:

1. Close all shut-off valves in the supply lines.
2. Close all shut-off valves in the outlet lines.
3. Wait until the plate heat exchanger has cooled down.
4. Open the flushing ports.
5. Empty the plate heat exchanger.

6. Flush the plate heat exchanger.  
For this, use a pump to pass one of the above mentioned cleaning agents through the plate heat exchanger for a prolonged period of time.
7. Carefully rinse the plate heat exchanger with water (e.g. using a high-pressure cleaner).

The cleaning effect is increased by the following measures:

- Use a greater mass flow than in normal operation.
- Pass the cleaning agent through the plate heat exchanger in the opposite direction to normal operation.

Leaving to work (for stubborn dirt):

1. Dismantle the plate heat exchanger.
2. Fill the plate heat exchanger with one of the above mentioned cleaning agents.
3. Leave the cleaning agent to work for at least six hours.  
In doing so, align the ports so that they are pointing upwards, so that any gases generated can escape.
4. Carefully rinse the plate heat exchanger with water (e.g. using a high-pressure cleaner).





If the specified cleaning methods are not sufficient, you should arrange for the plate heat exchanger to be cleaned by a service provider. Technical Support will be happy to recommend contracting companies on request.

## 4.1 Compressor transportation and storage

### Safety information for transport

Please observe the generally accepted safety and accident prevention regulations when transporting the compressor. BOGE accepts no liability for damage caused by improper transport.

	<p><b>ATTENTION</b>  <b>Risk of property damage!</b>          Improper transport may damage the compressor.</p> <ul style="list-style-type: none"> <li>→ The transport of the compressor should only be carried out by properly instructed and authorised personnel.</li> <li>→ The capacity of the lifting gear (lift truck or stacker) must correspond at least to the weight of the compressor/system.</li> <li>→ Note the location of the compressor's centre of gravity before lifting it. The location of the centre of gravity is specified both in the supplied dimensioned drawing and on the compressor packaging.</li> <li>→ All loose and rotatable parts must be removed before lifting the system.</li> <li>→ Lifting lugs on certain component parts (e.g. electric motor) are exclusively intended for lifting the individual part, not for lifting the entire compressor.</li> <li>→ The compressor is supplied filled with oil. Do not tilt it during transport!</li> </ul>
---	---

	<p><b>ATTENTION</b>  <b>Risk of property damage to machines with super sound insulation!</b>          Transporting or relocating the compressor with the sound curtain fitted can damage the external cladding and frame of the compressor.</p> <ul style="list-style-type: none"> <li>→ The sound curtain should only be assembled once the compressor has been set up and positioned at the installation site and all connections have been established.</li> </ul>
---	---

### Intermediate storage of the compressor before installation

If the compressor is not being installed immediately after delivery, it must be stored in a sheltered location. During intermediate storage, ensure that the compressor is protected from dust and humidity.

	<p>Observe the specifications and notes regarding the admissible environmental influences for intermediate storage (see chapter "4.2 Installing the compressor").</p> <p>BOGE will not assume any liability for consequential damage as the result of improper storage.</p> <p>Please contact Technical Support for advice regarding an extended period of intermediate storage.</p> <p>In the case of intermediate storage for more than 6 weeks, also comply with the information on commissioning after a prolonged period of inactivity (see "Shutting down/recommissioning the compressor" on page 58).</p>
---	--

### Transporting the compressor using a forklift truck

Move the compressor to the installation site as described below.



#### ATTENTION

##### Risk of property damage!

Improper transport may damage the compressor.

- Do not subject the safety cladding to force during transportation.
- Note the location of the compressor's centre of gravity before lifting it.

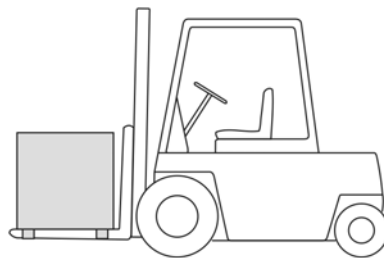

- Ensure that the forks are underneath the base frame or supplied transport pallet of the compressor (see figure).

Fig. 4.1: Transporting the compressor using a forklift truck

### Transporting the compressor with a crane



#### ATTENTION

##### Risk of property damage!

Improper transport may damage the compressor.

- Do not subject the safety cladding to force during transportation.
- Only lift the compressor using the supplied transport pallet.
- Use crane lifting gear (e.g. crane crosspiece), otherwise protect the compressor with shoring members (see following 2 illustrations).
- Remove transport bracing.
- Only use suitable slings of a sufficient minimum length.
- Note the location of the compressor's centre of gravity before lifting it.

If the compressor was delivered with transport pallet:

- Place the loops of the transport belts at the head ends underneath the supplied transport pallet of the compressor.

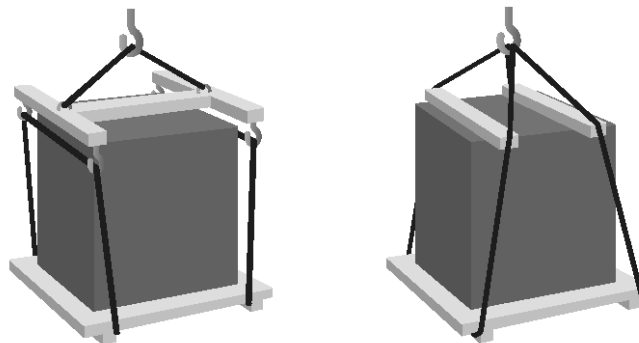

Fig. 4.2: Transporting the compressor with a crane (2 variants)

## 4.2 Installing the compressor

### Specifications for the operating area

#### Installation surface

The compressor can be installed on a level industrial floor with no foundations. No special fastening elements are required.



#### ATTENTION

##### Risk of property damage!

If the compressor is not standing flat on the ground on all feet or external sources of disturbance affect the machine directly, this can lead to material failure and damage to the unit.

→ There must be no external vibrations affecting the compressor unit.

#### Fire protection

The following regulations apply to rooms in which compressors with oil injection cooling are installed:



#### WARNING

##### Risk of fire!

With oil-injected compressors, inflammable substances may escape.

→ In the case of compressors with motor outputs **above 40 kW**, special fire protection must be put in place in the compressor room.

→ Compressors with motor outputs **above 100 kW** must be installed in a separate, fire-protected room.

#### Requirements for fire-protected compressor rooms:

- As a minimum, walls, ceilings, floors and doors must meet the requirements of **fire resistance class F30**.
- Flammable liquids must not be stored in the compressor room.
- The floor around the compressor must be made from non-flammable material.
- Do not allow leaking oil to spread across the floor.
- No inflammable substances may be located within a radius of at least three metres around the compressor.
- No inflammable system components such as cable ducts may run above the compressor.

**Sound protection**

Only install compressors in workrooms if the sound pressure level of their measuring surfaces does not exceed 85 dB (A).

**CAUTION****Danger due to noise!**

A sound pressure level exceeding 80 dB (A) can cause permanent hearing defects in persons who always work in the vicinity of the compressor.

→ These persons must wear hearing protection while working near the compressor.

**Admissible environmental influences**

The compressor room must be clean, dry, cool and free of dust.

**Admissible ambient temperatures**

- Installation altitude 0 to 1,000 MSL
- Closed room, frost-free, dry
- Ambient condition +5°C to +46°C
- Relative humidity 0% to 95%

**ATTENTION****Risk of property damage!**

Non-observance of the admissible ambient temperatures may lead to the following problems:

- Ambient temperature too high: The oil liquefies too much and sufficient lubricity can no longer be guaranteed.
- Ambient temperature too high: The compressor exceeds the maximum permitted final compression temperature and switches off.
- Ambient temperature too low: The oil becomes too viscous and sufficient lubricity can no longer be guaranteed.
- Ambient temperature too low: Pipes and valves may freeze up in some circumstances.

**Measures to be taken to ensure that admissible ambient temperatures are maintained:**

- Avoid having any heat-radiating pipelines or units in the vicinity of the compressor or insulate them well.
- Never install the compressor in the cooling air flow of other machinery.
- Provide the supply air inlets with adjustable louvres to ensure that the temperature does not fall below the minimum temperature in winter.

**Frost protection**

The compressor must be installed so that it is protected against frost. The BOGE frost-protection device is included as standard. This prevents the functional components of the compressor from freezing at ambient temperatures as low as -10°C.



## Ventilation of the compressor room

Non-observance of the following instructions can cause the maximum permitted final compression temperature to be exceeded. The compressor will switch itself off if this happens.

	<p><b>CAUTION</b></p> <p><b>Risk of poisoning or fire when compressing hazardous fluids.</b></p> <p>The intake and compression of hazardous gases, materials or substances can lead to a harmful concentration of these substances or increase the risk of fire.</p> <p>→ The compressor intake openings or ducts must be arranged in such a way that dangerous admixtures cannot be drawn in. Dangerous admixtures include solvent vapours, dusts and other harmful substances. Avoid creating flying sparks in the vicinity of the compressor.</p>
---	--

### Ventilation openings (free-standing installation)

- Position supply air intakes close to the floor.
- Position exhaust air outlets in the ceiling or at the top of the wall.
- The required cross sections for the supply air inlets (as well as for the flaps and weather protection grids) are indicated in the table.

### Supply air and exhaust air ducts

- The flow velocity in the ducts should not exceed 4 m/s.
- Never attach cooling air ducts to the compressor directly. Always use a compensator to avoid distortion and the transmission of vibrations.

### Fans

Ensure that the heated exhaust air is not taken in again.  
If necessary, the heated air must be extracted by fans.

To ensure perfect cooling even at higher temperatures in the summer, the fans must be designed as follows:

- The fan output must be approx. 10-15% greater than the sum of the required cooling air quantity for all the machinery operating in the room (VDMA standard sheet 4363 "Ventilation of operating rooms").
- For a free-standing installation, the cooling air requirement specified in table 4.1 corresponds to the required fan capacity.

### Supply air filter

- If there is a large quantity of dust in the compressor room, the compressor must be equipped with supply air filter mats (optional for both sides of a fixed machine).

**Cooling air requirement**

Please refer to the following table for the cooling air requirement and the size of the supply air inlets for your compressor. Ensure that flaps and weather protection grids have the necessary free cross section. We generally recommend that you contact a specialist company to carry out the duct design and construction work.

Type	Drive rating  [kW]	Air cooling			Water cooling <sup>1)</sup>
		Required cooling air flow for ventilation in accordance with VDMA 4363  [m <sup>3</sup> /h]	Required cross section of supply air with artificial ventilation in accordance with VDMA 4363  [m <sup>2</sup> ]	Cooling air requirement (volume flows for air cooling + compressor intake)  [m <sup>3</sup> /h]	Cooling air requirement for free-standing installation  [m <sup>3</sup> /h]
S 76-4	75	27,500	2.3	9,130	1,700
S 90-4	90	33,110	2.8	16,970	1,700
S 110-4	110	40,270	3.4	17,000	1,700
S 111-4	110	35,030	3.3	16,250	3,800
S 132-4	132	41,850	3.9	16,450	3,800
S 160-4	160	51,310	4.8	21,700	3,800
S 56-4 L	55	20,000	1.7	8,880	1,700
S 110-4 L	110	32,480	3.4	17,150	1,700
S 111-4 L	110	35,030	3.3	16,200	3,800
S 132-4 L	132	41,850	3.9	16,200	3,800
S 160-4 L	160	51,310	4.8	21,150	3,800
S 56-4 LF	55	20,370	1.7	8,930	1,700
S 76-4 LF	75	27,500	2.3	9,160	1,700
S 90-4 LF	90	33,110	2.8	16,990	1,700
S 110-4 LF	110	40,270	3.4	17,150	1,700
S 111-4 LF	110	35,030	3.3	16,250	3,800
S 132-4 LF	132	41,850	3.9	16,450	3,800
S 160-4 LF	160	51,310	4.8	21,650	3,800

<sup>1)</sup> For the cooling air requirement, a temperature difference of + 4°C between the room and ambient temperature has been taken as a basis.

**Table 4.1: Cooling air requirement, required supply air inlet and duct cross sections**

## Ventilation options

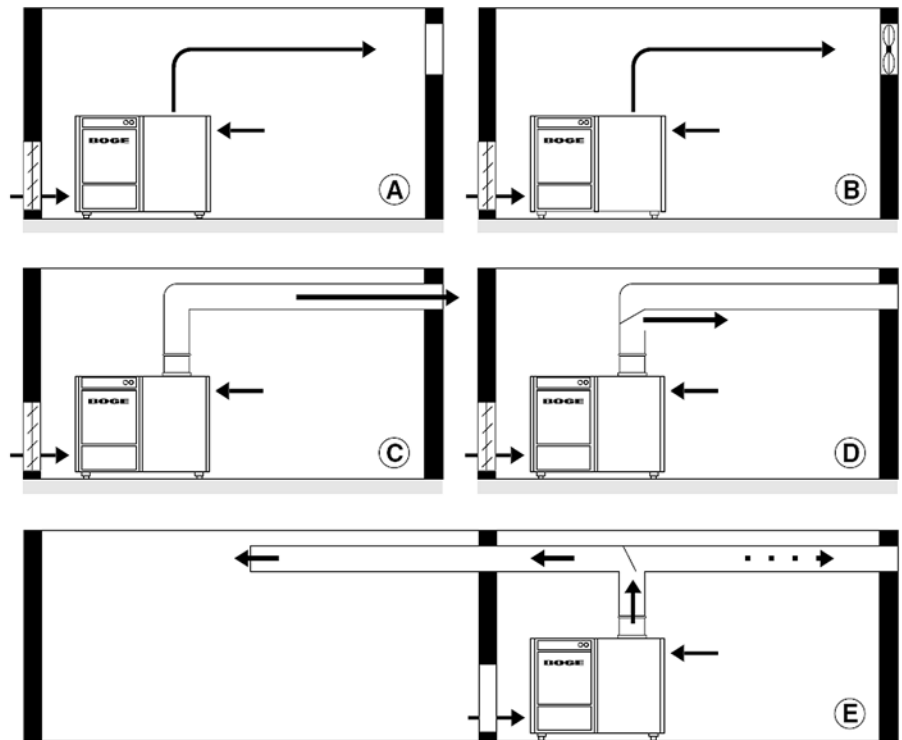

Fig. 4.3: Ventilation options

**A Supply air inlets and exhaust air outlets in the external walls (free-standing installation)**

**B Support from exhaust air fan**

**C Exhaust air duct to outside**

**D Exhaust air duct with air admission flap**

Warm exhaust air is added to the cold ambient air if required. This prevents the system from freezing up if temperatures are below freezing.

**E Use of warm exhaust air for heating**

In winter the warm exhaust air is used to heat rooms. In summer it is diverted outside.

## Checking the scope of the delivery

The scope of the delivery depends on your order.

Prior to commissioning, please check that all the required parts are available. Please check the order confirmation for any possible additional equipment.

The scope of the delivery includes the following components:

- Operating Instructions
- Keys
- Electric circuit diagram (in switch cabinet compartment)
- List of the electrical equipment (in switch cabinet compartment)
- Spare parts book
- Documents about options / accessories if necessary

## Positioning the compressor and aligning it



### ATTENTION

#### Risk of property damage!

Incorrect installation or alignment of the compressor may lead to malfunctions, leaks or damage caused by material wear / material fatigue.

- The compressor must be aligned horizontally and must stand firmly on the ground on all feet.
- Observe the minimum wall clearance according to the dimensioned drawing on all sides of the compressor.

1. Remove all packaging materials in and around the compressor.
2. Position the compressor and align it horizontally.

## Removing transport lock from the drive (only available on S 111-4 to S 160-4 LF)

For transport, the frame of the drive unit on machines S 111-4 to S 160-4 LF is screwed onto the base frame by the transport lock. The screw connections of the transport lock are located **at two points underneath the drive motor**, which are indicated by the arrows in the figure below:

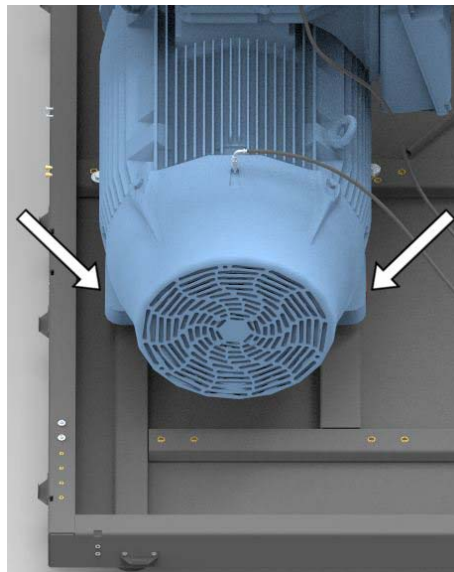

Fig. 4.4: Position of the transport lock screw connections



### ATTENTION

#### Risk of property damage!

Operating the compressor without first removing the transport locks will cause damage to the compressor.

- The transport locks must be removed before commissioning the compressor.

To remove the transport lock from the drive:

1. Remove the cladding of the compressor before connecting it, so that the areas 4.4 indicated by the arrows in figure are accessible.
2. Undo the two screws (one on the long side of each motor), see figure 4.5 (1).
3. Take the screws out from above, see figure 4.5 (2).
4. Remove the screws and red spacer sleeves, see figure 4.5 (3).
  - The transport lock on the drive is removed.
  - Subsequently, the transport lock must be removed from the compressed air-oil receiver.

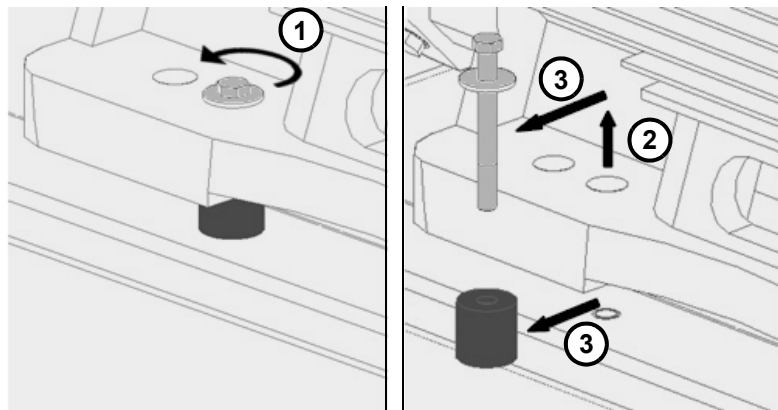

Fig. 4.5: Removing the transport lock (Drive)

### Removing the transport lock from the compressed air-oil receiver

For transport, the compressed air-oil receiver is screwed onto the machine housing by a transport lock. Depending on the size of the machine, there are 2 different configurations for the transport lock.

For machines S 56-4 L to S 110-4 LF, the red transport lock (3) is fitted as follows:

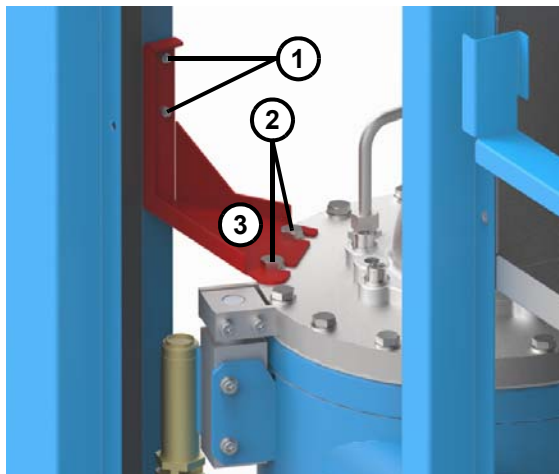

Fig. 4.6: Transport lock (3) on the compressed air-oil receiver (S 56-4 L...S 110-4 LF)

For machines S 111-4 to S 160-4 L, the red transport lock (3) is fitted as follows:

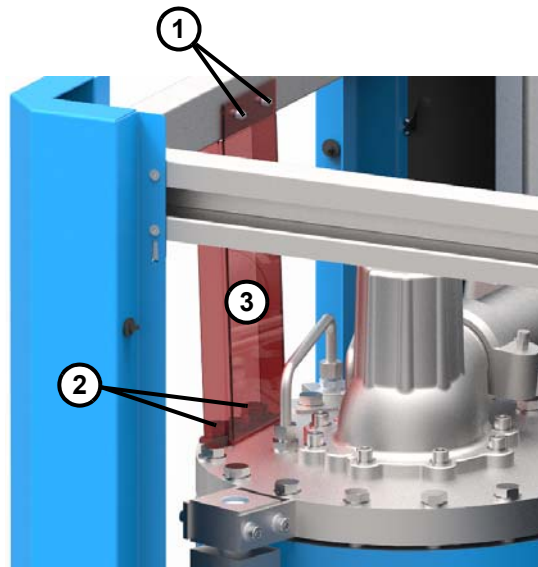

Fig. 4.7: Transport lock (3) on the compressed air-oil receiver (S 111-4 to S 160-4 LF)



#### ATTENTION

##### Risk of property damage!

Operating the compressor without first removing the transport locks will cause damage to the compressor.

→ The transport locks must be removed before commissioning the compressor.

The procedure for removing the lock is the same for all machines, regardless of the size. To remove the transport lock (3) from the compressed air-oil receiver (see also Figure 4.6 or 4.7):

1. Remove the cladding of the compressor before connecting it, so that the transport lock (3) is accessible.
2. Two screws included. Unscrew the flat washers (1) from the outside and remove them.
3. Unscrew the two screws (2) and flat washers from the compressed air-oil receiver which were used to fit the transport lock (3) to the container.
4. Removing the transport lock (3).
- 5a. Machines S 56-4 L to S 110-4 LF: Screw the 2 previously loosened screws (2) and the flat washers of the compressed air-oil receiver back in again with a torque of **68 Nm**.
- 5b. Machines S 111-4 to S 160-4 LF: Screw the 2 previously loosened screws (2) and the flat washers of the compressed air-oil receiver back in again with a torque of **106 Nm**.
6. Refit all removed cladding.
  - All transport locks are removed.

## Checking the oil level

BOGE compressors are supplied with a complete oil fill. Prior to commissioning, check the oil level as described in the Servicing section.



### Specifications for the installation of separate compressed air receivers

The compressor can be connected to the compressed air network directly or indirectly via a separately installed compressed air receiver. If the compressed air is to be fed into a separate compressed air receiver, please observe the following:

	<p><b>WARNING</b></p> <p><b>Risk of injury due to overpressure!</b></p> <p>In the event of damage, malfunctioning or incorrect use, air under high pressure can escape from pipelines or individual components and cause severe injuries.</p> <ul style="list-style-type: none"> <li>→ Protect the compressed air receiver against mechanical damage (e.g. from falling objects).</li> <li>→ Exposure of the compressed air receiver to additional static and dynamic loads, voltages or vibration stress is not permitted.</li> <li>→ Operate the compressed air receiver and its equipment from a safe location.</li> <li>→ Observe safety areas and safety clearances. Ensure that the compressed air receiver is easily accessible from all sides (e.g. for periodic tests). The required operating and maintenance areas should be taken from the attached dimensioned drawing.</li> <li>→ Ensure that the compressed air receiver is positioned securely. It must not shift or tilt when subjected to external forces. This also includes the additional weight imposed during a pressure test!</li> <li>→ The compressed air receiver must <b>not</b> be bolted to the ground.</li> <li>→ Ensure that the name plate is clearly visible.</li> <li>→ Ensure that the compressed air receiver is adequately protected against corrosion.</li> <li>→ Only use the compressed air receiver in accordance with EN 286 for compressors operating in cut-in and cut-out mode where the pressure fluctuation range amounts to <math>\Delta p \leq 10\%</math> of the maximum operating pressure.</li> <li>→ Only use the compressed air receiver in accordance with AD 2000 for compressors operating in cut-in and cut-out mode where the pressure fluctuation range amounts to <math>\Delta p \leq 20\%</math> of the maximum operating pressure.</li> </ul> <p>Read and observe the documentation provided with the receiver!</p>
---	---

### Specifications for condensate disposal

The air taken in contains water in the form of vapour, which turns into condensate during compression. The condensate that accrues contains oil and in some cases it may contain foreign substances from the environment.

 	<p><b>ATTENTION</b></p> <p><b>Danger of environmental damage!</b></p> <p>If accumulated condensate is not disposed of properly, this can endanger persons and the environment.</p> <ul style="list-style-type: none"> <li>→ Dispose of the condensate properly.</li> <li>→ When disposing of the collected condensate, the wastewater regulations of the local water authority must be adhered to. Observe water protection regulations.</li> </ul>
--	---



BOGE recommends the use of an oil-water separator. The BOGE oil-water separator separates the oil from the condensate. The cleaned water can be introduced into the public wastewater network. The oil is collected in a separate container. It must be disposed of in an environmentally-friendly manner. If the oil emulsifies due to particular operating conditions, an emulsion splitting unit must be used.

## 4.3 Establishing the connections

### Safety prior to commencing work

BOGE compressors are delivered as complete units ready for connection. During assembly, only the work described in this chapter has to be carried out. Always observe the following warning notices:



#### WARNING

##### Risk of injury due to moving parts or sharp edges!

If the following work is carried out by unauthorised or unqualified personnel, this may lead to serious accidents due to inadequate specialist knowledge.

- All assembly work must only be carried out by duly authorised and qualified personnel (BOGE Service personnel).
- Lay all power supply lines in a trip-proof and barrier-free manner so that potential accidents can be avoided.
- Wear PPE.



#### WARNING

##### Risk of injury due to overpressure!

In the event of damage, malfunctioning or incorrect use, fluids under high pressure can escape from pipes or individual components and cause severe injuries.

- Work on the system and components may only be carried out by skilled personnel.
- Wear PPE.
- Depressurise pressurised system components before working on them.
- Only operate the compressor unit with suitable safety devices installed.
- Safety devices must not be removed or shut down.
- The maximum permitted operating limits must not be exceeded.



#### ATTENTION

##### Risk of property damage!

Incorrectly installed connections may damage or destroy the compressor.

- All assembly work must only be carried out by duly authorised and qualified personnel (BOGE Service personnel).



Prior to delivery, each compressor undergoes a test run at the factory. It is carefully tested and set. However, damage during transport cannot be excluded.

- Please check the compressor immediately after delivery and make a complaint to the last carrier about any damage, even if the packaging is not damaged. In order to secure your claim for damages against the shipping company, we would advise you to temporarily leave the machines, equipment and packaging materials in the condition in which you found them when you identified the damage.
- Inspect the compressor for external transport damage before commissioning.
- Observe the compressor very closely during commissioning and the subsequent test run.
- Switch the compressor off immediately if malfunctions or faults occur. In this case, notify Technical Support.

### Connecting the compressor to the compressed air network

- Connect the compressor to the compressed air network or to a separate compressed air receiver.  
Use a BOGE high-pressure hose for this purpose.



#### CAUTION

##### **Danger due to missing shut-off valve (ball valve)!**

A shut-off valve (ball valve) is not included as standard in the scope of delivery of the compressor. If no ball valve is installed by the customer, then there is the risk of injury during maintenance work, especially due to the unexpected escape of compressed air.

- To perform maintenance work safely, a shut-off valve (ball valve) must be installed by the customer on the compressed air outlet of the compressor. This work must be performed by authorised and qualified personnel.



The screw compressor can be disconnected from the compressed air network using the installed shut-off valve (ball valve). This simplifies maintenance work on the compressor in particular.

BOGE recommends positioning the shut-off valve (ball valve) after the installed high-pressure hose.



Do not install a non-return valve in the pressure line after the compressed air outlet nozzle.

The compressor is already equipped with a non-return valve.

## Connecting the water cooling (optional)



### CAUTION

#### Risk of injury due to overpressure!

Risk of injury due to pressurised water escaping when connecting the cooling water system.

- ➔ Close the external water line prior to connection.
- ➔ The connection should only be established by authorised and qualified personnel.

The cooling water circuit in the compressor is already completely piped in the factory.

During assembly, only the following work remains to be carried out:

1. Check whether the water network meets the necessary requirements ("Cooling water data" on page 31) and whether the quality of the cooling water is adequate ("Required cooling water quality" on page 31).
2. Connect the cooling water intake and outlet to the water network.

When installing the water cooling, the following additional components must be provided on site:

- Dirt trap  
The dirt trap at the cooling water intake protects the cooler from dirt accumulation. Pore width: max. 0.6 mm
- Expansion vessel and safety valve



In closed cooling systems, if the shut-off valves in the intake and outlet lines are closed at the same time, a sealed space is created. If the water in this space heats up, it expands, and the pressure increases. In order to prevent damage to the cooler, an expansion vessel and a safety valve must be installed.

## Establishing the electrical connection



### DANGER

#### Danger of death due to electric current!

Danger of death from contact with live parts, defective insulation or components when establishing the electrical connection.

- ➔ Ensure that work on the electrical equipment of the compressor is only carried out by authorised electricians.
- ➔ When connecting to the mains, observe the national and international regulations in force (e.g. VDE regulations, DIN / EN standards) and the local safety regulations.
- ➔ Observe the regulations of your local electricity supplier regarding the capacity of your electrical network.

**DANGER****Danger of death due to electric current!**

Danger of death from contact with live parts, defective insulation or electrical installations in the electrical installation room or switch cabinet of the compressor when working on the electrics.

→ Ensure that work on the electrical equipment of the compressor is only carried out by authorised electricians.

**Prior to working in the electrical installation room, for drives with frequency converters:**

→ After switching off the power supply, wait until the fan comes to a stop and all indicator lights go out.

→ Wait for the discharge time of at least 5 minutes before starting work. No covers or safety cladding may be opened before this period of time has passed.

**Prior to work on the switch cabinet:**

The relay outputs may still be live even when the main switch (option) is switched off.

→ Before working on live parts in the switch cabinet, ensure that the compressor has been fully disconnected from the mains.

**As a general rule, before carrying out any electrical work:**

1. De-energise the components.
2. Take precautions to prevent them being switched back on again.
3. Check that all system components are de-energised.
4. Earth and short circuit.
5. Cover or enclose adjacent live parts.

**Mains disconnecting device**

Every compressor unit must be fitted with a mains disconnecting device in accordance with EN 60204-1. An optional main switch also fulfils this requirement.

**Rated voltage**

The data of your mains (operating voltage, control voltage, current type, frequency, etc.) must be identical to the data on the rating plate on the switch cabinet. In the event of deviations, please contact Technical Support or your supplier.

Refer to the "Technical data" section regarding the design of the fuse protection.

**Connecting the supply lines**

1. Check all terminals in the switch cabinet are firmly secured.
2. If necessary, retighten the screw connections.
3. Guide the power supply cables through the threaded cable connection(s).
4. Connect leads L1, L2, L3, N, PE (PEN) firmly to the supply terminal. A clockwise rotating field must be created.
5. Retighten the electrical connections after the first 50 operating hours.

**CAUTION****Risk of injury from automatic restart!**

When the automatic restart (Auto-Restart) is activated, the compressor will start automatically following a power failure.

Prerequisite: the net pressure is lower than the set switch-on pressure.

**Special features of drives with frequency converters****DANGER****Danger of death due to electric current!**

Electrical drive systems with frequency converters may have a ground leakage current greater than 10 mA, depending on operation.

- For the electrical connection of the compressor, the required measures must therefore be implemented in accordance with DIN EN 60204-1 and DIN EN 50178.
- The connection must be carried out when the system is stationary.
- One or more of the following conditions for the protective conductor system must be met:
  1. The protective conductor must have a minimum cross section of 10 mm<sup>2</sup> Cu over its entire length.
  2. Where the protective conductor has a cross section of less than 10 mm<sup>2</sup> Cu, a second protective conductor with at least the same cross section must be provided up to the point where the protective conductor has a cross section of no less than 10 mm<sup>2</sup>.
  3. Automatic switch-off of the power supply in the event of loss of continuity of the protective conductor.
- Observe additional national regulations.

**4.4 Fitting additional compressor equipment****Fitting the super sound insulation (option)**

The super sound insulation is available as an option for compressors in this series. On this version, the sound-optimising supply air splitters are already installed inside the compressor at the factory. However, the four side plates of the sound curtain must be fitted by the customer.

**CAUTION****Risk of injury due to sharp edges!**

Risk of cut injuries if the assembly work is carried out without the appropriate personal protective equipment.

- The assembly work must only be carried out by authorised and qualified personnel.
- Wear PPE, e.g. protective gloves.

**ATTENTION****Risk of property damage!**

Transporting or relocating the compressor with the sound curtain fitted can damage the external cladding and frame of the compressor.

→ The sound curtain should only be assembled once the compressor has been set up and positioned at the installation site and all connections have been established.

**Prerequisites for assembly work:**

- The compressor has been set up and positioned at the installation site.
- All connections have been established.
- The compressor has not yet been commissioned.
- The Emergency Stop button has been pressed, the mains disconnecting device has been opened (or the optional main switch has been pressed) and it has been secured with a padlock to prevent it from being accidentally switched on again.
- It has been checked that no voltage is present.

To fit the sound curtain:

1. Fit the two longer plates (2) of the sound curtain to the two long sides of the compressor base frame (1) with four M6 screws (4) each, as shown in figure 4.8.

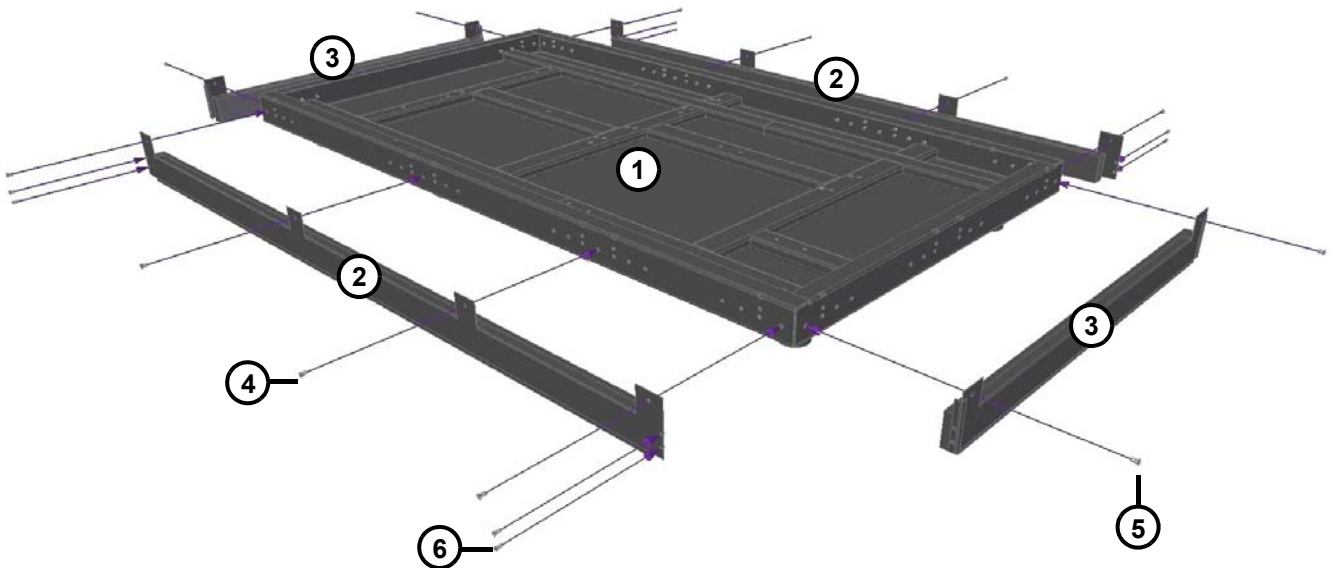
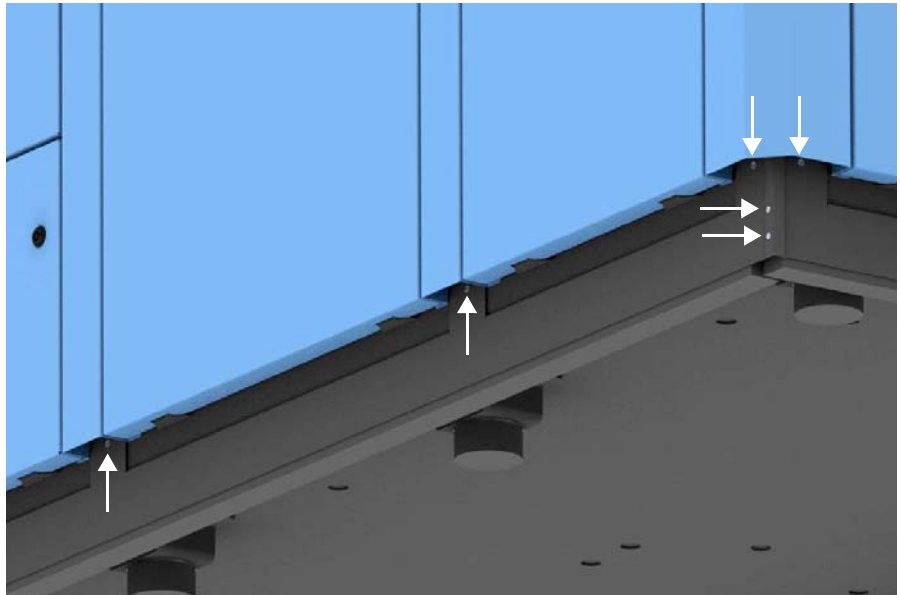

Fig. 4.8: Individual parts of the sound curtain and base frame of the compressor

2. Fit the two shorter plates (3) of the sound curtain to the two short sides of the compressor base frame (1) with two M6 screws (5) each, as shown in figure 4.8.
3. Screw together the long and short side plates in each corner with two M5 screws each (6) as shown in figure 4.8.
  - The sound curtain has been fitted. The super sound insulation is operational. Figure 4.9 shows a section of the underside of the compressor with the correct screw connections (arrows).



*Fig. 4.9: Fitted sound curtain with correct screw connections (arrows)*

## 5.1 Commissioning the compressor

### Safety prior to commencing work

**WARNING****Risk of injury due to moving parts or sharp edges!**

If the compressor is commissioned by unauthorised or unqualified personnel, this may lead to serious accidents due to inadequate specialist knowledge.

- The compressor should only be commissioned by duly authorised and qualified personnel.
- Wear PPE.

**WARNING****Risk of injury due to overpressure!**

In the event of damage, malfunctioning or incorrect use, fluids under high pressure can escape from pipes or individual components and cause severe injuries.

- Work on the system and components may only be carried out by authorised and qualified personnel.
- Wear PPE.
- Depressurise pressurised system components before working on them.
- Only operate the compressor unit with suitable safety devices installed.
- Safety devices must not be removed or shut down.
- The maximum permitted operating limits must not be exceeded.



We recommend drawing up a commissioning report in which the test results during commissioning can be recorded.

## Checking installation conditions

Before commissioning the compressor, all conditions for correct installation of the machine must be fulfilled. The following checklist can be used for this purpose:

"Checking installation conditions" checklist			
Product name: S 56-4 L...S 160-4 LF			
Installation location:		Date of installation location inspection:	
Category		Inspection parts	Result (Y)
Installation location	Installation area	Is there sufficient space to operate the machine?	<input type="checkbox"/>
	Installation location	Does the installation location meet all the criteria specified in these instructions (fire protection regulations for the compressor room, cleanliness)?	<input type="checkbox"/>
		Are the machine's intake air and exhaust air outlets free?	<input type="checkbox"/>
	Maintenance	Is there sufficient space for servicing and repair work?	<input type="checkbox"/>
Electricity	Miscellaneous	Is there a stable power supply?	<input type="checkbox"/>
	Distribution system	Is the capacity of the circuit breaker and power cable sufficient?	<input type="checkbox"/>
		Distance of the circuit breaker to the installation location	<input type="checkbox"/>
Operational readiness	Compressor	Have the transport locks been removed?	<input type="checkbox"/>
		Is the sound curtain for super sound insulation (option) fitted?	<input type="checkbox"/>
Cooling water (water-cooled machines only)	Intake	Is the water OK in terms of quality, pressure and temperature?	<input type="checkbox"/>
	Intake and outlet	Are the pipelines intact?	<input type="checkbox"/>
		Is there a shut-off device?	<input type="checkbox"/>
Lubricant	Compressor – oil circuit	Oil level checked?	<input type="checkbox"/>



"Checking installation conditions" checklist			
Compressed air	Compressed air outlet	Are the connecting leads suitable (operating conditions observed, compensation considered if necessary)?	<input type="checkbox"/>
		Is there a shut-off device?	<input type="checkbox"/>
Environment	Installation surface	No external vibrations?	<input type="checkbox"/>
		Is the installation surface secure, level and even enough for the load?	<input type="checkbox"/>
	Intake/cooling air	Is the ambient air free from dust?	<input type="checkbox"/>
		Is the ambient air dry?	<input type="checkbox"/>
		Does the intake air meet the required conditions (temperature, quality, contaminant content)?	<input type="checkbox"/>

Table 5.1: "Checking installation conditions" checklist

**Checking the rotation direction of the drive and fan motors**

Always check the respective motor's rotation direction is correct prior to initial commissioning or after replacing the motor.

	<p><b>ATTENTION</b>  <b>Risk of property damage!</b>                  Even brief operation in the wrong rotation direction (for more than 5 seconds) can cause significant property damage.</p> <ul style="list-style-type: none"> <li>➔ Always check the drive and fan motors' rotation direction prior to initial commissioning.</li> <li>➔ Record the test result on the commissioning report.</li> </ul>
---	--

Ensure that the rotation direction matches the arrow on the airend and the fan.

1. Close the mains disconnecting device (or press the optional main switch).
2. Switch the compressor on and immediately off again to check the rotation direction.

### Changing the rotation direction



#### **DANGER**

##### **Danger of death due to electric current!**

Coming into contact with live parts, defective insulation or components can be fatal.

- Ensure that work on the electrical equipment of the compressor is only carried out by authorised electricians.
- Open the mains disconnecting device (or press the optional main switch) and use a padlock to prevent it from being accidentally switched on again.

- Swap two phases (L1, L2 or L3) in the power cable.

### Checking the compressed air, oil and cooling water pipelines for leaks



#### **WARNING**

##### **Risk of injury due to overpressure or leaks!**

In the event of damage, malfunctioning or incorrect use, fluids under high pressure can escape from pipes or individual components and cause severe injuries.

In the case of leaks in the oil or cooling water circuit, there is a danger of slipping in puddles of oil or water and falling.

- Any work on the system components carrying pressurised media must only be carried out by duly authorised and qualified personnel.
- The compressed air outlet and cooling water connections must be checked for leaks immediately after switching on the machine.
- Make sure to maintain a safe distance during the inspection.

1. Close the mains disconnecting device (or press the optional main switch).
2. Switch the compressor on and check the piping systems for leaks.
3. Switch off the compressor.
4. Press the Emergency Stop button, open the mains disconnecting device (or press the optional main switch) and use a padlock to prevent it from being accidentally switched on again.



#### **CAUTION**

##### **Risk of injury due to sharp edges!**

Risk of cut injuries if the work is carried out without the corresponding personal protective equipment.

- Wear PPE, e.g. protective gloves.

5. If required, have the leaks repaired by authorised and qualified personnel.
6. Log the test results.

To prevent leaks:

1. Check screw connections on the pipelines on a weekly basis and retighten if necessary.
2. Check that the oil filter is seated so that it is hand-tight.

### Opening the shut-off valves

All shut-off valves must be opened prior to commissioning:

1. If present, open the ball valve on the compressor outlet.
2. Open all other shut-off devices for compressed air and cooling water.

### Conducting a test run

To ensure the safety and functionality of the overall system for standard operation, the machine must complete a test run. The results of the test run should be recorded in the commissioning report.

1. Close the mains disconnecting device (or press the optional main switch).
2. Switch on the compressor using the ON button on the compressor control.
  - The compressor starts.
  - The compressor switches off automatically once the pre-set switch-off pressure has been reached.
3. Monitor the net pressure on the control unit's display and/or on the pressure gauge showing the net pressure.
4. If required, adjust the operating pressure (pressure setpoint).
  - For the control function see the control display.
5. Switch off the compressor after a several-hour test run at maximum operating load.
6. Record the test result on the commissioning report.
  - If the test run is completed safely and with no technical issues, the compressor is ready for operation.

### Checking the pressure settings

The pressure settings are checked using the compressor control. Read the supplied operating instructions for the compressor control.

## 5.2 Shutting down/recommissioning the compressor

### Safety prior to commencing work

	<p><b>CAUTION</b>  <b>Risk of injury due to moving parts, thermal or pressure-related hazards!</b></p> <p>If the following work is carried out by unauthorised or unqualified personnel, this may lead to serious accidents due to inadequate specialist knowledge.</p> <ul style="list-style-type: none"> <li>→ The following work should only be carried out by duly authorised and qualified personnel.</li> <li>→ Wear PPE.</li> <li>→ Press the Emergency Stop button, open the mains disconnecting device (or press the optional main switch) and use a padlock to prevent it from being accidentally switched on again.</li> <li>→ Depressurise or block pressurised pipelines. Check that all pressurised compressor components are fully depressurised.</li> <li>→ Allow hot components to cool down sufficiently.</li> </ul>
---	--

### Shutting down the compressor

	<p><b>ATTENTION</b>  <b>Risk of property damage!</b></p> <p>Coolers may be damaged by corrosion, deposits, condensate formation or thermal effects.</p> <ul style="list-style-type: none"> <li>→ Remove the cooling water if the compressor is to be stored for a prolonged period of time.</li> <li>→ Before storing the compressor for a prolonged period, contact Technical Support for advice so that the compressor can be protected in the appropriate manner.</li> </ul>
---	---

	<p><b>CAUTION</b>  <b>Risk of injury from moving parts and overpressure!</b></p> <p>If the compressor is shut down by unauthorised or unqualified personnel, this may lead to serious accidents due to inadequate specialist knowledge.</p> <ul style="list-style-type: none"> <li>→ Dismantling of the compressor should only be carried out by duly authorised and qualified personnel.</li> <li>→ Wear PPE.</li> <li>→ Press the Emergency Stop button, open the mains disconnecting device (or press the optional main switch) and use a padlock to prevent it from being accidentally switched on again.</li> <li>→ Depressurise or block pressurised pipelines. Check that all pressurised compressor components are fully depressurised.</li> </ul>
---	--

### Intermediate storage of the compressor for prolonged periods

Contact Technical Support for advice in the event of planned prolonged periods of downtime or intermediate storage.

### Commissioning after a prolonged period of downtime: Adding oil

After a period of downtime of more than six weeks, the suction regulator must be filled with a small amount of oil before restarting the compressor.

#### Prerequisites for maintenance work:

- The system pressure display shows 0 bar.
- The Emergency Stop button has been pressed, the mains disconnecting device has been opened (or the optional main switch has been pressed) and it has been secured with a padlock to prevent it from being accidentally switched on again.
- It has been checked that no voltage is present.
- The compressor has been disconnected from the compressed air network.

To fill the suction regulator with a small amount of oil:

1. Remove the service side cladding so that the suction regulator is accessible via the airend.



#### ATTENTION

##### Risk of property damage!

Mixing different types of oils may cause uneven distribution of the necessary lubricant and damage to the compressor.

- ➔ Never mix different types or brands of oil.
- ➔ Only use the type of oil used for operating the compressor to fill the suction regulator.

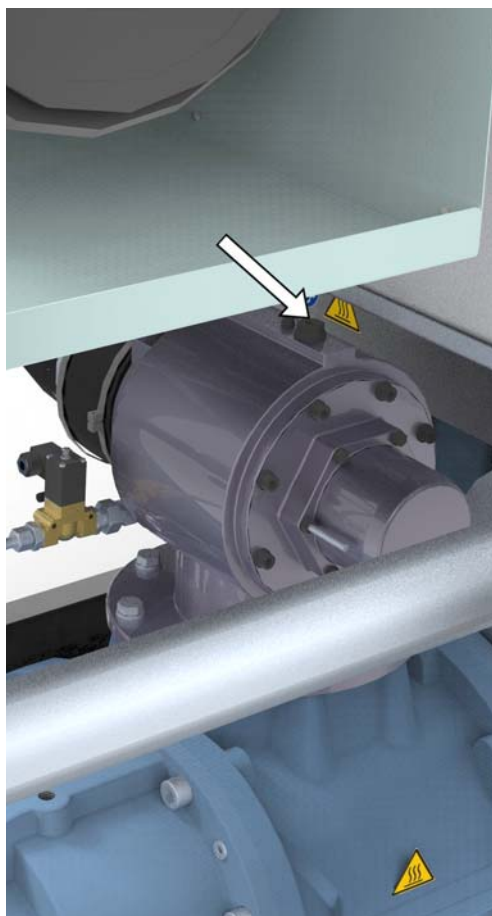

Fig. 5.1: Suction regulator

2. Unscrew the plug on the suction regulator (see arrow).
- 3a. S 56-4 L to S 110-4 LF: Fill the suction regulator with approx. 4 l of compressor oil.
- 3b. S 111-4 to S 160-4 LF: Fill the suction regulator with approx. 7 l of compressor oil.
4. Screw the plug back on.

To ensure even lubrication of the airend when starting the compressor:

5. Turn the airend on the coupling by hand **one rotation in the opposite direction to the specified rotation direction.**
6. Turn the airend on the coupling **5 to 10 rotations in the specified rotation direction.**
  - The oil has been distributed evenly.
  - Excess oil has been expelled from the airend.
7. Refit the service side cladding.

## 5.3 Dismantling



To avoid any danger when dismantling the compressor, please consult Technical Support:

**Telephone: +49 5206 601-140**



### DANGER

#### Danger of death due to electric current!

Coming into contact with live parts, defective insulation or components can be fatal.

- All work on the electrical system must only be carried out by authorised electricians.
- Before starting work, the connection cable from the mains to the switch cabinet must be disconnected and secured to prevent it from being switched on again.



### CAUTION

#### Risk of injury due to moving parts, thermal or pressure-related hazards!

If the compressor is dismantled by unauthorised or unqualified personnel, this may lead to serious accidents due to inadequate specialist knowledge.

- Dismantling of the compressor should only be carried out by duly authorised and qualified personnel.
- Wear PPE.
- Press the Emergency Stop button, open the mains disconnecting device (or press the optional main switch) and use a padlock to prevent it from being accidentally switched on again.
- Depressurise or block pressurised pipelines. Check that all pressurised compressor components are fully depressurised.
- Allow hot components to cool down sufficiently.





## 6.1 Basic information on servicing/maintenance

### The BOGE servicing concept

Your compressor has an integrated monitoring system in the form of the compressor control, which informs you in good time about the most important maintenance work via a maintenance warning.

The basic servicing intervals for the compressor are set by BOGE Service personnel via the control during commissioning, depending on the ambient conditions at the factory.

This enables the most important maintenance work to be performed regularly and, over the long-term, to keep compressor wear to a minimum and to guarantee the machine has a long service life.



You should also observe the information in the supplied operating instructions for accessories and optional equipment.

### Safety prior to commencing work

#### As a general rule:

- Ensure maintenance work is only carried out by BOGE Service personnel, authorised and qualified personnel or appropriately trained personnel.
- Personal protective equipment must be worn when performing maintenance work.
- Prior to starting any maintenance work, the compressor must be shut down as described on page 64 before any safety claddings or safety devices are removed.
- The safety claddings or safety devices must be refitted immediately after completing the maintenance work.
- Heavy components may only be lifted by multiple persons in accordance with the local industrial safety regulations.
- Only use original spare parts and operating materials approved by BOGE for the maintenance and service work.
- When the automatic restart (Auto-Restart) is activated, the compressor will start automatically following a power failure. Prerequisite: the net pressure is lower than the set switch-on pressure.

## Measures to be taken prior to maintenance work



### **DANGER**

#### **Danger of death due to electric current!**

Coming into contact with live parts, defective insulation or components can be fatal.

- Ensure that work on the electrical equipment of the compressor is only carried out by authorised electricians.
- Always adhere to the procedure described below for all maintenance work. Never omit a single safety step. Otherwise you risk injury due to restarting, electric shock or self-releasing parts.

### **Shutting down the compressor**

1. Switch off the compressor using the OFF button.
2. The system pressure must be 0 bar.
3. Press the Emergency Stop button.
4. Open the mains disconnecting device (or press the optional main switch) and use a padlock to prevent it from being accidentally switched on again.
5. Fix a warning sign to the control and fill in the name of the person who is authorised to switch the machine back on.
6. Check that all system components are definitely de-energised.
7. Allow all hot compressor components to cool to 50°C before starting any work.
8. Disconnect the compressor from the compressed air network.  
To do so, if available, close the ball valve installed on the compressed air outlet by the customer.
  - The compressor has been shut down and (automatically) vented.
9. Remove all the safety claddings necessary for maintenance work.



The safety measures that must be carried out before commencing any maintenance work are listed in this chapter under the "Prerequisites" prior to the relevant maintenance instructions.

### Measures to be taken following maintenance work

#### Restoring the compressor to an operational state

1. Refit all removed safety claddings.
2. If present, open the ball valve on the compressed air outlet.
3. Prior to switching on again, ensure that nobody else is still working on the compressor.
4. Only then may the warning sign be removed and the mains disconnecting device switched back on again.
5. Unlock the Emergency Stop button.  
→ The compressor is ready for operation again.

### Servicing by BOGE Service

Have your compressor completely checked and serviced by BOGE Service annually or after every 3,000 operating hours.



#### Servicing contract.

Enter into a servicing contract with BOGE.

BOGE Service will carry out the proper servicing on your compressor at regular intervals. As well as adhering to the warranty claim conditions, this guarantees maximum safety and reliability of your compressed air supply.

### Overview of regular maintenance work

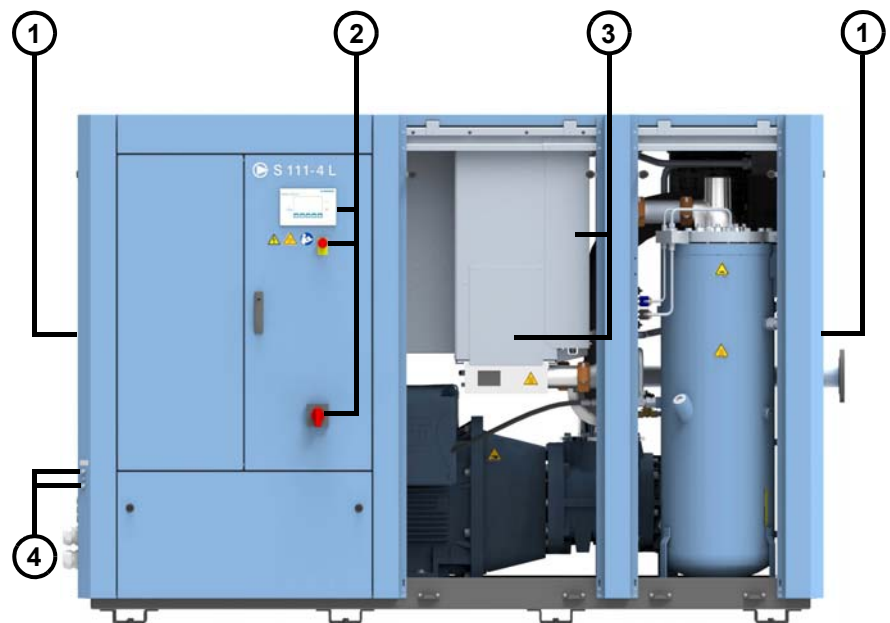

Fig. 6.1: Overview of regular maintenance work I

- 1 Change supply air filter mats (standard on S-4 LF only)
- 2 Check pressure/final compression temperature/system depressurisation/ Emergency Stop button and main switch (optional) for proper functioning.
- 3 Clean the compressed air-oil cooler
- 4 Manually lubricate motor bearings, A and B sides

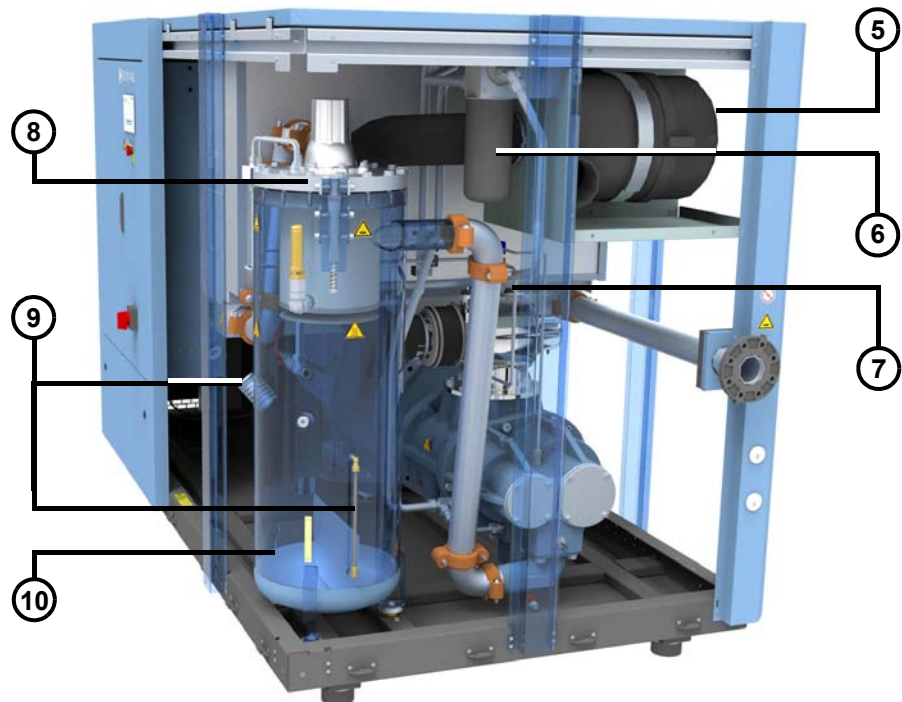

Fig. 6.2: Overview of regular maintenance work II

- 5 Check suction filter
  - Clean filter and cartridge
  - Change filter cartridge
- 6 Change oil filter
- 7 After a long period of downtime: fill suction regulator with oil
- 8 Change oil separator
- 9 – Check the oil level
  - Top up the oil
- 10 Oil change

## Servicing intervals

The servicing intervals specified in the following tables are based on average operating and ambient conditions.

Extreme conditions may require shorter servicing intervals.

The first table contains servicing and maintenance work to be carried out by the customer at regular intervals in between the annual BOGE Service maintenance work. The intervals for these servicing tasks are shorter (weekly/monthly/every 1,500 operating hours).

The intervals for the maintenance and servicing work listed in the second table are longer (every 3,000/9,000 operating hours, or yearly/every 2 years).

To ensure the warranty claim conditions are adhered to, BOGE recommends having this work carried out by BOGE Service.



Note down all maintenance work in the table on the final pages. This will facilitate troubleshooting for BOGE Service.

**Maintenance work between (annual) servicing intervals**

The following servicing and maintenance work must be carried out by you and will ensure your compressor functions flawlessly between fixed servicing intervals (see page 71).

Maintenance Work	Page
<b>Weekly:</b>	
Check compressor for leaks – visual inspection	–
Check the final compression temperature (setpoint: 70...100°C)	Control
Check system depressurisation on system pressure indicator (setpoint after approx.: 1 minute: 0-0.3 bar)	Control
Check/replace supply air filter mats (optional on S-4 (L)/standard on S-4 LF)	71
<b>Monthly:</b>	
Check Emergency Stop button for proper functioning	–
Check main switch (mains disconnecting device) (optional)	–
Check operating pressure, adjust if necessary	Control
Check screw connections on the compressor are tightened properly	–
Clean/replace suction filter cartridge	73
Check oil level and top up if needed	75
Clean compressed air-oil cooler	78
<b>Every 1,500 operating hours:</b>	
Check that electrical connections have been tightened properly	–
Clean oil cooler (water cooling)	80
Check pressure hoses for leaks / wear – visual inspection	80
Clean Duotherm plate heat exchanger, depending on water quality (optional)	33
<b>Compressed air treatment/accessories maintenance:</b>	
Check/repair cyclone separator	See separate instructions
Check/repair condensate drain	
Check/repair condensate cleaner	

Table 6.1: Maintenance work between servicing intervals

**Maintenance work at fixed servicing intervals**

To ensure the warranty claim conditions are adhered to, BOGE recommends having the following servicing and maintenance work carried out by certified BOGE Service personnel using original spare parts. For the control intervals, servicing kits in the form of cairpacs are available, which contain the necessary service and wearing parts.

**ATTENTION****Compressor damage caused by improper servicing!**

An incorrect oil change interval or failure to comply with the interval may damage or destroy the compressor.

- ➔ Ensure that the specific oil change intervals are observed.
- ➔ If none of the oils specified below are used, please ensure that you contact Technical Support regarding the oil change interval:
  - 3000plus
  - FoodLub-H1 S
  - Syprem S (only for directly coupled compressors)
  - Syprem SX (for compressors with transmission drive)

Maintenance work (BOGE Service personnel)	Page
<b>Every 3,000 operating hours <sup>1)</sup> (or annually):</b>	
Check compressor for leaks	–
Checking the condition of the coupling – visual inspection	–
Replace suction filter	73
Check minimum pressure valve and repair using the set of wearing parts if necessary	–
Function check of the safety valve	94
Check oil regulator and repair using the set of wearing parts if necessary	–
Change oil filter	81
Change oil when using BOGE 3000plus and FoodLub-H1 S <sup>2)</sup>	83
Change oil separator when using BOGE 3000plus and FoodLub-H1 S	90
<b>Every 9,000 operating hours <sup>1)</sup> (or every 2 years):</b>	
Check suction regulator and replace/repair if necessary (set of wearing parts)	–
Check solenoid valve(s) and replace if necessary	–
Check quick-start valve and replace if necessary (Optional on S-4 (L)/standard on S-4 LF)	–
Change oil when using BOGE Syprem S/SX <sup>2)</sup>	83
Change oil separator when using BOGE Syprem S/SX	90
<b>Special maintenance work and servicing intervals (see also from page 95 onwards):</b>	
Flush the oil circuit	Servicing interval: – If the oil is heavily contaminated. – Before changing the oil type.
Manual relubrication system: Lubricate the drive motor bearings	Lubrication interval: Every 3,000 operating hours (or annually) <sup>1) 3)</sup>
Automatic relubrication system (optional): Change grease cartridges	Change interval: When a message is output by the control.
Having the drive motor bearings replaced (50/60 Hz, directly coupled machines and machines with transmission drive)	Replace after: – 40,000 operating hours <sup>4)</sup>
Having the drive motor bearings replaced (50/60 Hz, frequency-controlled machines S-4 LF)	Replace after: – 20,000 operating hours <sup>4)</sup>
Have the airend bearings changed	Change interval: Please contact Technical Support.

<sup>1)</sup> If the compressor is not used frequently, servicing must then be carried out in line with the specified interval (weekly/monthly/yearly/every 2 years) regardless of the number of operating hours.

<sup>2)</sup> The specified intervals only apply when using the stipulated BOGE compressor oil. Depending on the ambient temperature, different service lives are entirely possible. In this case, have the oil analysed by your BOGE Service team.

<sup>3)</sup> Lubrication interval for compressors with < 3,000 h on the motor rating plate: When the machine is been in operation for the number of operating hours on the motor rating plate.

<sup>4)</sup> Increased or less thermal stress (due to increased or reduced coolant temperature) reduces or lengthens the number of operating hours, after which the bearings must be replaced.

**Table 6.2: Maintenance work at fixed servicing intervals**

**General information  
on the lubricants used**

Detailed information on the lubricants used can be found in the safety data sheets available on request.

**CAUTION****Risk of injury due to contact with hazardous substances, e.g. from inhalation!**

Oils pose a potential danger to health and the environment as a result of their content (additives).

- Avoid contact with skin and eyes. Wear protective gloves made of resistant plastic. Wash thoroughly after contact with oils.
- Do not inhale vapours or mists.
- Protect the environment. Avoid oil spillages.
- Eating or drinking while working with oils is prohibited.
- Fire, naked flames and smoking are strictly prohibited when handling oils.
- Heed the information on the relevant safety data sheets.

**ATTENTION****Compressor damage caused by improper servicing!**

Mixing different types or brands of oils in the oil circuit may damage or destroy the compressor.

- Always use the same type of oil for refilling/topping up.
- The oil circuit must be flushed before changing the type of oil (see "Flushing the oil circuit" on page 95 for more information).

**Disposal of used operating materials****ATTENTION****Danger of environmental damage!**

Hazardous substances, e.g. lubricants and cleaning agents, must be handled and disposed of in accordance with legal regulations.

- Ensure that the operating materials are disposed of correctly.
- Do not mix any waste oil generated with other substances or liquids.
- Used oil filters and oil separator cartridges must be disposed of as hazardous waste, not with general waste.



## Spare and wearing parts



### Caution!

#### Risk of injury when using unsuitable materials and components!

If original spare parts, lubricants and operating materials approved by BOGE are not used during repair or servicing, there is a risk of injury as a result of mechanical failure, or serious property damage.

→ Only use original spare parts, lubricants and operating materials approved by BOGE during repair or servicing.



BOGE accepts no liability for damage caused by the use of other spare parts and operating materials.

## 6.2 Maintenance work between fixed servicing intervals

### Weekly: Check/replace supply air filter mats

The supply air filter mats positioned on both sides of the machine are optionally available for S-4 (L) machines and are included as standard on S-4 LF machines.

#### Testing interval:

- Visual inspection once a week, however at least every 500 operating hours.
- Reduce interval if the air taken in is heavily polluted.

#### Change interval:

- When dirt becomes encrusted on the filter mats.
- If the final compression temperature increases by 4 to 5°C above its set-point. The encrusted dirt on the filter mats prevents an adequate supply of cooling air.

### Changing the filter mats

#### Prerequisites for maintenance work:

- The compressor has been switched off using the OFF button.
- The Emergency Stop button has been pressed, the mains disconnecting device has been opened (or the optional main switch has been pressed) and it has been secured with a padlock to prevent it from being accidentally switched on again.
- It has been checked that no voltage is present.
- All hot components have cooled down.

To change the filter mats on the power supply side:

	<p><b>CAUTION</b></p> <p><b>Risk of injury due to sharp edges and exposure to dust!</b></p> <p>Risk of cut injuries or irritation of the respiratory tract if the work is carried out without the corresponding personal protective equipment.</p> <p>→ The maintenance work should only be carried out by authorised and qualified personnel.</p> <p>→ Wear PPE, e.g. protective gloves, respiratory protection if necessary.</p>
---	--

1. Take the filter mats (1) out of the holder from above as shown below.

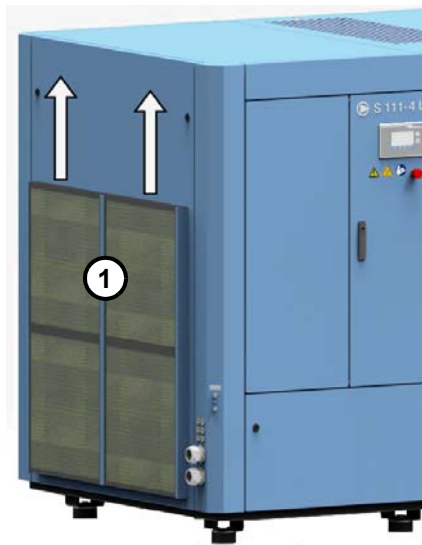

Fig. 6.3: Changing the filter mats on the power supply side

2. Insert the new filter mats into the holder.  
→ The filter mats on the power supply side have been changed. Then change the filter mat on the compressed air outlet side of the machine.

To change the filter mat on the compressed air outlet side of the machine:

1. Remove the side cladding from the machine as shown in figure 6.4 (1).
2. Take the filter mat out of the holder on the inside of the cladding from above as shown in figure 6.4 (2).
3. Insert a new filter mat into the holder.
4. Refit the side cladding to the machine.  
→ All supply air filter mats have been changed.

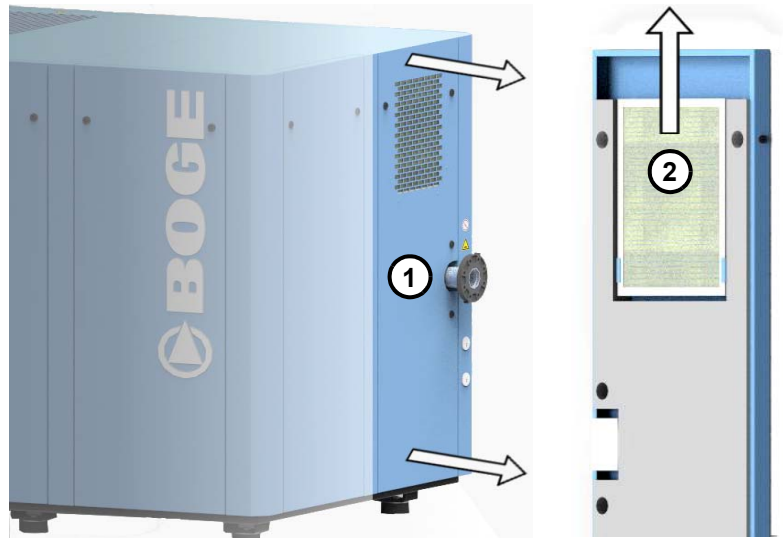

Fig. 6.4: Changing the filter mat on the compressed air outlet side

**Monthly: Clean/replace the suction filter**

**Cleaning interval:**

- Once a month, however at least every 500 operating hours.
- Reduce interval if the air taken in is heavily polluted.

**Change interval:**

- If damaged.
- After it has been cleaned twice.
- Also every 3,000 operating hours.

**Cleaning/replacing the filter**

**Prerequisites for maintenance work:**

- The compressor has been switched off using the OFF button.
- The Emergency Stop button has been pressed, the mains disconnecting device has been opened (or the optional main switch has been pressed) and it has been secured with a padlock to prevent it from being accidentally switched on again.
- It has been checked that no voltage is present.
- All hot components have cooled down.

To remove the filter cartridge:

	<p><b>CAUTION</b></p> <p><b>Risk of injury due to sharp edges and exposure to dust!</b></p> <p>Risk of cut injuries or irritation of the respiratory tract if the work is carried out without the corresponding personal protective equipment.</p> <ul style="list-style-type: none"> <li>➔ The maintenance work should only be carried out by authorised and qualified personnel.</li> <li>➔ Wear PPE, e.g. protective gloves, respiratory protection.</li> </ul>
---	--

1. Remove the service side cladding.
2. Undo the clamps on the side of the filter housing (see arrow, figure 6.5).
3. Remove the lid of the filter housing.

4. Take the filter cartridge out of the filter housing.
  - If the filter cartridge has been cleaned less than twice and is not damaged, the filter cartridge can be cleaned (steps 4a through c) and reinserted (step 5 onwards).
  - If the filter cartridge has already been cleaned twice or is damaged, the filter cartridge must be changed (step 5 onwards).

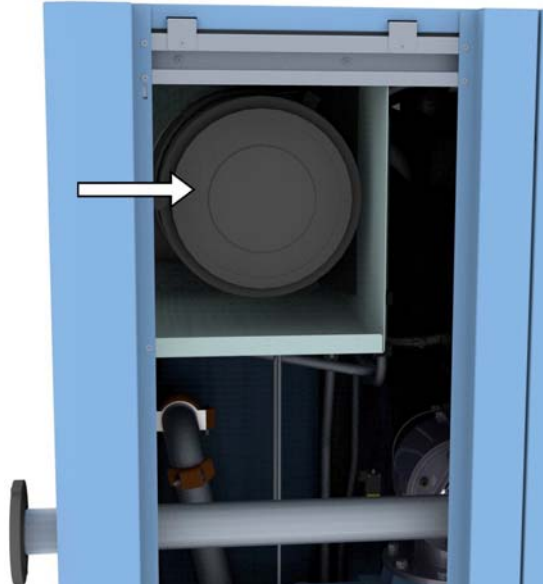

Fig. 6.5: Position of the suction filter

To clean the filter cartridge:



**ATTENTION**

**Risk of property damage!**

The filters may be damaged by unqualified cleaning methods or unsuitable cleaning products.

- Do not clean filter cartridges in liquids.
- Do not use any hard objects for cleaning.

- 4a. Tap the filter cartridge with your hand to knock out coarse dust.
- 4b. Blow out fine dust using dry compressed air (maximum pressure 5 bar) from the inside to the outside.
- 4c. Clean the sealing surfaces of the filter cartridge.

To insert the filter cartridge:

5. Insert a new or cleaned filter cartridge into the filter housing.
6. Attach the lid of the filter case.
7. Apply the clamps on the side of the filter housing.
8. Refit the service side cladding.

**Monthly: Check oil level, top up if needed**

**Testing interval:**

- Prior to initial commissioning of the compressor.
- Then on a monthly basis.

**Top up interval:**

- When the oil level is at or below the “Min” mark (see fig. 6.6).

	<p><b>ATTENTION</b></p> <p><b>Compressor damage caused by improper servicing!</b></p> <p>Mixing different types or brands of oils in the oil circuit may damage or destroy the compressor.</p> <ul style="list-style-type: none"> <li>➔ Always use the same type of oil for refilling/topping up.</li> <li>➔ The oil circuit must be flushed before changing the type of oil (see “Flushing the oil circuit” on page 95 for more information).</li> </ul>
---	---

**Checking the oil level**

**Prerequisites for maintenance work:**

- The compressor has been switched off using the OFF button.
- The Emergency Stop button has been pressed, the mains disconnecting device has been opened (or the optional main switch has been pressed) and it has been secured with a padlock to prevent it from being accidentally switched on again.
- It has been checked that no voltage is present.
- All hot components have cooled down.

To check the oil level:

	<p><b>WARNING</b></p> <p><b>Risk of injury from moving parts and overpressure!</b></p> <p>If the safety measures listed under the prerequisites for the maintenance work have not been fully carried out, there is an increased risk of injury from moving or pressurised components of the machine.</p> <ul style="list-style-type: none"> <li>➔ All the above-mentioned prerequisites for the maintenance work must be fulfilled prior to commencing work (see also page 64).</li> </ul>
---	--

	<p><b>CAUTION</b></p> <p><b>Risk of injury due to sharp edges!</b></p> <p>Risk of cut injuries if the work is carried out without the corresponding personal protective equipment.</p> <ul style="list-style-type: none"> <li>➔ The maintenance work should only be carried out by authorised and qualified personnel.</li> <li>➔ Wear PPE, e.g. protective gloves.</li> </ul>
---	--

1. Remove the side cladding from the machine so that the oil level display is visible on the compressed air-oil receiver (see figure 6.6).

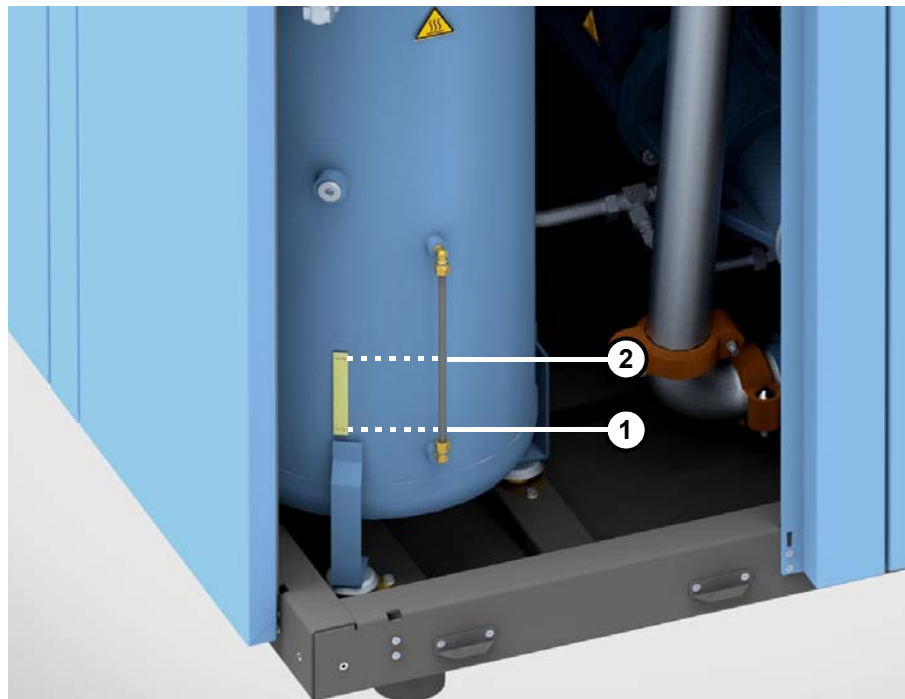

Fig. 6.6: Oil level display on the compressed air-oil container

2. Carry out a visual inspection.

- If the oil level is between the “Min” (1) and “Max” (2) marks, the system contains sufficient oil.
- If the oil level is at or below the “Min” (1) mark, the oil must be topped up.

### Topping up the oil

#### Prerequisites for maintenance work:

- The compressor has been switched off using the OFF button.
- The compressor has been vented and the system pressure display shows 0 bar.
- The Emergency Stop button has been pressed, the mains disconnecting device has been opened (or the optional main switch has been pressed) and it has been secured with a padlock to prevent it from being accidentally switched on again.
- It has been checked that no voltage is present.
- All hot components have cooled down.
- The compressor has been disconnected from the compressed air network.
- The oil has settled.

To top up the oil:

	<p><b>WARNING</b></p> <p><b>Risk of injury from moving parts and overpressure!</b></p> <p>If the safety measures listed under the prerequisites for the maintenance work have not been fully carried out, there is an increased risk of injury from moving or pressurised components of the machine.</p> <p>→ All the above-mentioned prerequisites for the maintenance work must be fulfilled prior to commencing work (see also p. 64).</p>
---	---

**CAUTION****Risk of injury due to sharp edges and exposure to dust!**

Risk of cut injuries or irritation of the respiratory tract if the work is carried out without the corresponding personal protective equipment.

- The maintenance work should only be carried out by authorised and qualified personnel.
- Wear PPE, e.g. protective gloves, respiratory protection.

**CAUTION****Risk of scalds from hot oil!**

Contact with hot oil from the oil circuit may cause burns.

- Wear PPE as well as protective goggles and gloves.

1. Remove the service side cladding so that the compressed air-oil container with oil filler neck (see arrow, figure 6.7) is accessible.



*Fig. 6.7: Oil filler neck on the compressed air-oil container*

2. Unscrew the locking screw from the oil filler neck on the compressed air-oil container.
3. Fill with oil to the "Max" (2) mark (see figure 6.6).
4. Check the new oil level on the oil level display (see figure 6.6).
  - When the new oil level is at the "Max" (2) mark, the oil circuit contains sufficient oil.
5. Screw the locking screw onto the oil filler neck on the compressed air-oil container.
6. Refit the service side cladding.

### Monthly: Clean the compressed air-oil cooler (air cooling)

#### Cleaning interval:

- Once a month, however at least every 500 operating hours.
- Reduce interval if the air taken in is heavily polluted.



The service life of the compressed air-oil cooler depends on the degree of soiling (dust, oil vapour) in the intake cooling air. Heavy external soiling of the cooler leads to an excessively high temperature in the oil circuit.

### Cleaning the cooler

#### Prerequisites for maintenance work:

- The compressor has been switched off using the OFF button.
- The compressor has been vented and the system pressure display shows 0 bar.
- The Emergency Stop button has been pressed, the mains disconnecting device has been opened (or the optional main switch has been pressed) and it has been secured with a padlock to prevent it from being accidentally switched on again.
- It has been checked that no voltage is present.
- All hot components have cooled down.
- The compressor has been disconnected from the compressed air network.

To clean the compressed air-oil cooler:



#### WARNING

##### Risk of injury from moving parts and overpressure!

If the safety measures listed under the prerequisites for the maintenance work have not been fully carried out, there is an increased risk of injury from moving or pressurised components of the machine.

- ➔ All the above-mentioned prerequisites for the maintenance work must be fulfilled prior to commencing work (see also p. 64).



#### CAUTION

##### Risk of injury due to hot surfaces or exposure to dust!

Risk of burns or irritation of the respiratory tract if the work is carried out without the corresponding personal protective equipment.

- ➔ The maintenance work should only be carried out by authorised and qualified personnel.
- ➔ Wear PPE, e.g. protective gloves, respiratory protection.

1. Remove the service side claddings so that the air and oil sides of the cooler are accessible (see figure 6.8).





Fig. 6.8: Servicing side for cleaning the compressed air-oil cooler



**ATTENTION**

**Risk of property damage!**

The cooler can be damaged if unsuitable cleaning tools are used.

→ Do not use any sharp objects to clean the cooler.

2. Remove the accumulated dirt from the air side (1) and oil side (2) using a fibrous brush (see figure 6.9).

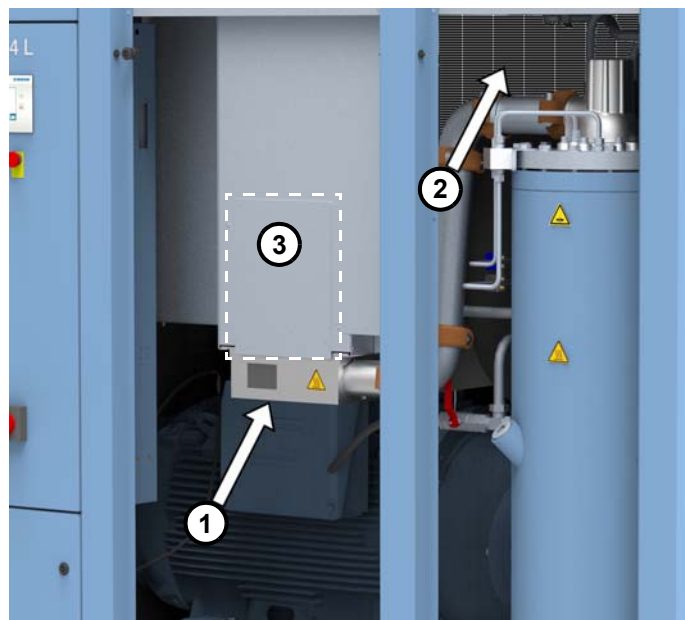
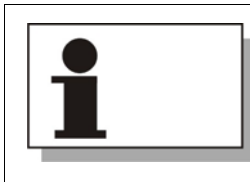

Fig. 6.9: Cleaning the compressed air-oil cooler

3. Blow the cooler fins on the air side (1) and oil side (2) with compressed air to remove loosened contaminants.
4. Undo the four screws on the opening of the service cover (3) (the size of the cover can vary depending on the machine type).

5. Take off the cover.
6. Suck contaminants out of the service opening using an industrial vacuum cleaner.
7. Screw the cover back onto the service opening using the four screws.
8. Suck any remaining contaminants off the cooler fins on the air side (1) and oil side (2) using an industrial vacuum cleaner.
9. Refit the service side claddings.



If the cooler is very heavily soiled (cleaning with compressed air is no longer possible), it must be dismantled and cleaned by BOGE Service personnel.

**Every 1,500 operating hours: Clean oil cooler (water cooling)**

**Cleaning interval:**

- After 1,500 operating hours but no less than once a year.
- When there is significant limescale or dirt accumulation.



The service life of the cooler depends on the degree of soiling and the level of limescale in the cooling water. In the case of severe contamination, check the cooler at an appropriate, earlier interval.

**Cleaning the cooler**

Cleaning should be performed as described for the BOGE Duotherm-BPT plate heat exchanger (see page 32 ff.).

**Every 1,500 operating hours: Check pressure hoses for leaks/wear**

**Testing interval:**

- After approx. 1,500 operating hours, but at least once a year.



**WARNING**

**Risk of injury due to unsuitable and old pressure hoses!**

Unsuitable, e.g. old, pressure hoses cannot withstand the operating loads and may burst, causing serious injuries.

- ➔ Do not re-use pressure hoses.
- ➔ Defective or leaking pressure hoses must never be repaired; they must always be replaced immediately.
- ➔ When replacing them, only use original spare parts approved by BOGE.

Pressure hoses that are installed in the compressor or have been fitted to the compressed air outlet must be checked at regular intervals to inspect their condition.

**Checking the pressure hoses****Prerequisites for maintenance work:**

- The compressor has been switched off using the OFF button.
- The Emergency Stop button has been pressed, the mains disconnecting device has been opened (or the optional main switch has been pressed) and it has been secured with a padlock to prevent it from being accidentally switched on again.
- It has been checked that no voltage is present.
- All hot components have cooled down.

To check the pressure hoses:

- Carry out a visual inspection of the pressure hoses installed in the compressor or fitted to the compressed air outlet. When doing so, remember that leaks can be heard and identified by compressed air escaping.
  - If a pressure hose inside the compressor shows signs of wear or damage, it must be replaced immediately by BOGE service personnel.
  - If the pressure hose on the compressed air outlet of the compressor shows signs of wear or damage, it must be replaced immediately by authorised and qualified personnel.



Do not use pressure hoses beyond their permissible service life. The manufacturing date is printed on the hose.

BOGE recommends replacing pressure hoses after a usage period of **max. 5 years** (including storage period).

## 6.3 Performing maintenance work at fixed servicing intervals

The following sections provide a description of the maintenance work at fixed servicing intervals. These tasks are also listed in the table on page 69. To ensure the warranty claim conditions are adhered to, BOGE recommends having this work carried out by certified BOGE Service personnel using original spare parts.

### Every 3,000 operating hours/annually: Change oil filter

**Change interval:**

- After 3,000 operating hours but no less than once a year.
- At each oil change.
- If the control outputs a message stating that the oil filter differential pressure is too high (option).

**Changing the filter element****Prerequisites for maintenance work:**

- The compressor has been switched off using the OFF button.
- The compressor has been vented and the system pressure display shows 0 bar.
- The Emergency Stop button has been pressed, the mains disconnecting device has been opened (or the optional main switch has been pressed) and it has been secured with a padlock to prevent it from being accidentally switched on again.

- It has been checked that no voltage is present.
- All hot components have cooled down.
- The compressor has been disconnected from the compressed air network.
- The oil has settled.

To change the oil filter:

1. Remove the side cladding from the machine so that the oil filter (1) is accessible (see figure 6.10).

**CAUTION****Risk of scalds from hot oil!**

Contact with hot oil from the oil circuit may cause burns.

→ Wear PPE as well as protective goggles and gloves.

2. Unscrew the contaminated oil filter (1) in the direction of the arrow by hand or using a strap wrench (see fig. 6.10).



*Fig. 6.10: Changing the oil filter*

3. Collect escaping oil and dispose of it in an environmentally-friendly manner.
4. Fill the new oil filter with compressor oil.
5. Lightly oil the sealing ring of the new oil filter.
6. Screw on the oil filter by hand in the opposite direction to the arrow (see fig. 6.10).

**ATTENTION****Risk of property damage!**

Incorrect installation may damage the oil filter or sealing ring.

→ Do not use any tools to screw on the new oil filter. Tightening the oil filter by hand is perfectly adequate.

7. Refit the side cladding to the machine.

**Checking for leaks**

To check the changed oil filter for leaks:

8. If present, open the ball valve on the compressed air outlet.

9. Switch on the compressor and allow it to warm up to operating temperature.

**WARNING****Risk of injury from moving parts and overpressure!**

If the safety measures listed under the prerequisites for the maintenance work "Changing the filter element" have not been fully carried out, there is an increased risk of injury from moving or pressurised components of the machine.

→ All the above-mentioned prerequisites for the maintenance work must be fulfilled prior to commencing work (see also page 81).



10. Remove the side cladding from the machine.

11. Carry out a visual inspection of the oil filter to check for leaks.

**CAUTION****Risk of scalds from hot oil!**

Contact with hot oil from the oil circuit may cause burns.

→ Wear PPE as well as protective goggles and gloves.

12. If necessary, retighten components by hand (procedure as previously described).

13. Check the oil level (see page 75).

14. If necessary, top up the oil (see page 76).

**Every 3,000/9,000 operating hours: Change oil****Change interval:**

- For BOGE 3000plus and FoodLub-H1S compressor oils: After 3,000 operating hours but no less than once a year.
- For Syprem S/SX compressor oil: After 9,000 operating hours but no later than every two years.



**ATTENTION**

**Compressor damage caused by improper servicing!**

An incorrect oil change interval or failure to comply with the interval may damage or destroy the compressor.

- ➔ The corresponding oil change times must be observed for other types of oils.
- ➔ If none of the oils specified below are used, please ensure that you contact Technical Support regarding the oil change interval:
  - 3000plus
  - FoodLub-H1 S
  - Syprem S/SX



The service lives of the oil, the oil filter and the oil separators are reduced under the following circumstances:

- When operating the compressor under extreme ambient temperatures.
- If the air taken in is heavily polluted.

The maintenance work for the oil change consists of four activities performed in succession, which are described in detail in this section:

- Pressurising the pressure cushion.
- Draining old oil.
- Adding new oil.
- Checking leak tightness and oil level.

**Pressurising the pressure cushion**

The oil drain on the compressed air-oil container is located at the lowest point in the system. To drain the oil prior to changing it, a low pressure cushion (approx. 2 bar system pressure) is therefore required. The air cushion presses the oil through the drain hose – which must be attached to the oil drain – into a suitable collecting vessel.

**Prerequisites for maintenance work:**

- The compressor has been switched off using the OFF button.
- All hot components have cooled down.

To pressurise a pressure cushion:

1. Start Service Run using the control.
  - ➔ The compressor starts and the motor is switched off again shortly thereafter.
  - ➔ The control displays the “Service Run” state.
  - ➔ The system pressure is approx. 2 bar.



**WARNING**

**Risk of injury from moving parts and overpressure!**

Risk of crushing or injury from pressurised components if the work is carried out without the relevant qualification.

- ➔ This maintenance work should only be carried out by authorised and qualified personnel.

**CAUTION****Risk of injury due to hot surfaces or exposure to dust!**

Risk of burns or irritation of the respiratory tract if the work is carried out without the corresponding personal protective equipment.

→ Wear PPE, e.g. protective gloves, respiratory protection.

2. Remove the service side cladding so that the ventilation opening (1) of the solenoid valve is accessible (see figure 6.11).
3. Screw the supplied cap nut (2) onto the ventilation opening (see figure 6.11).  
→ The pressure cushion can now also be kept at 2 bar, even if the compressor has been disconnected from the mains.
4. Stop Service Run using the control.  
→ The Service Run is complete and the control displays the “Off” compressor state.
5. Press the Emergency Stop button.
6. Open the mains disconnecting device (or press the optional main switch).
7. Secure the mains disconnecting device against accidental switching on using a padlock.  
→ The pressure cushion remains at 2 bar.  
→ The old oil can be drained.

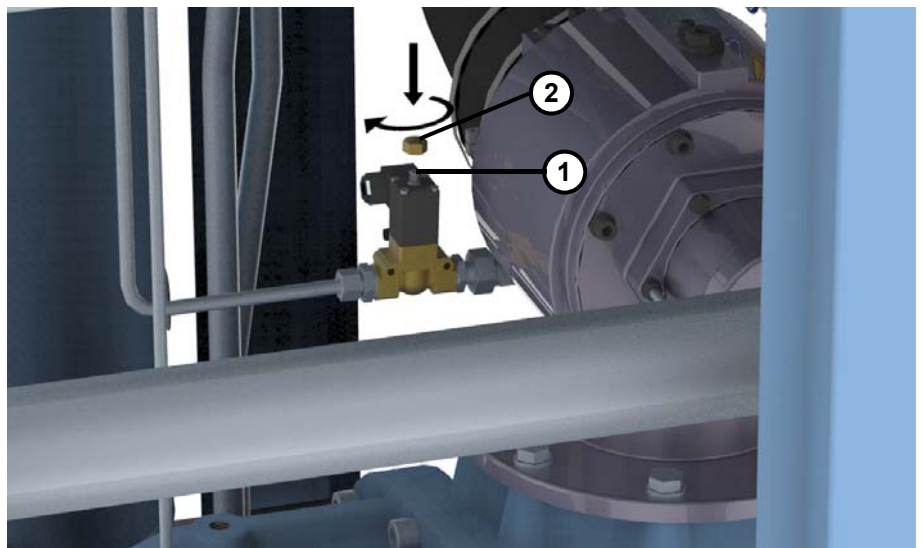



Fig. 6.11: Screw the cap nut onto the ventilation opening

**Draining old oil****Prerequisites for maintenance work:**

- The compressor has been switched off using the OFF button.
- The Emergency Stop button has been pressed, the mains disconnecting device has been opened (or the optional main switch has been pressed) and it has been secured with a padlock to prevent it from being accidentally switched on again.
- It has been checked that no voltage is present.
- The pressure cushion is pressurised (see system pressure on the control = 2 bar).
- The compressor has been disconnected from the compressed air network.

To drain the old oil:

	<p><b>WARNING</b> <b>Risk of injury from moving parts and overpressure!</b> Risk of crushing or injury from pressurised components if the work is carried out without the relevant qualification. → This maintenance work should only be carried out by authorised and qualified personnel.</p>
---	---

	<p><b>CAUTION</b> <b>Risk of injury due to hot surfaces!</b> Risk of burns if the work is carried out without the corresponding personal protective equipment. → Wear PPE, e.g. protective gloves, respiratory protection.</p>
---	--

8. Remove the service side cladding so that the oil drain is accessible (see figure 6.12).
9. Feed the oil drain hose (1) out of the machine.
10. Route the hose to a suitable collecting vessel, e.g. large canister.

	<p><b>CAUTION</b> <b>Risk of scalds from hot oil!</b> Contact with hot oil from the oil circuit may cause burns. → Wear PPE as well as protective goggles and gloves.</p>
---	---

11. Open the stopcock slowly (see arrow in figure 6.12).  
→ The pressure cushion presses the oil into the vessel.
12. When the oil stops flowing, close the stopcock.



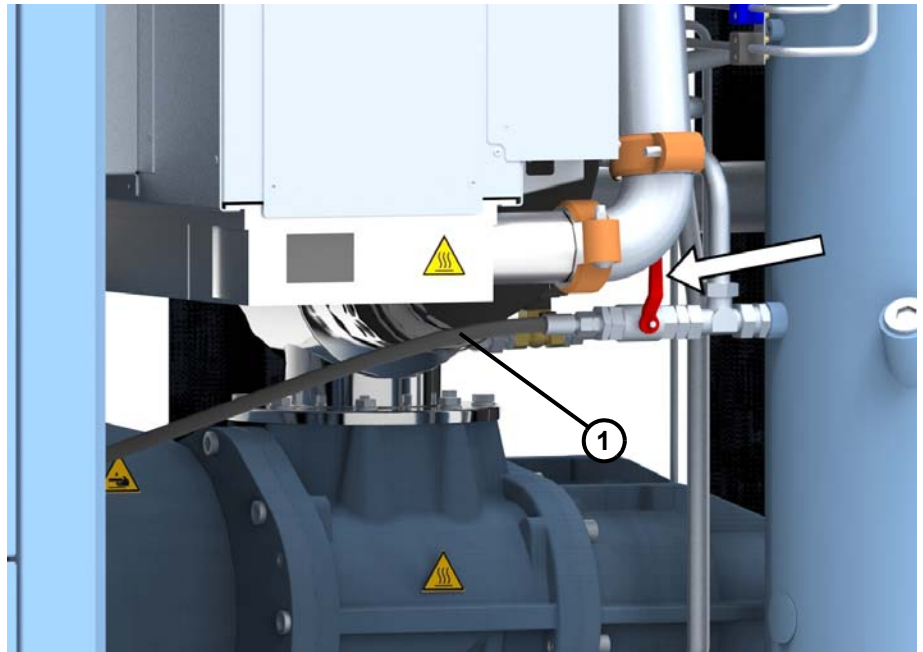

Fig. 6.12: Oil drain on the compressed air-oil container

The residual oil in the compressed air-oil cooler must be drained in a second step:

13. Remove the service side claddings so that the locking screw (1) (see arrow in figure 6.13) on the compressed air-oil cooler is accessible.
14. Use a suitable vessel, e.g. canister, for the residual oil (approx. 20 litres).



**CAUTION**

**Risk of scalds from hot oil!**

Contact with hot oil from the oil circuit may cause burns.

→ Wear PPE as well as protective goggles and gloves.

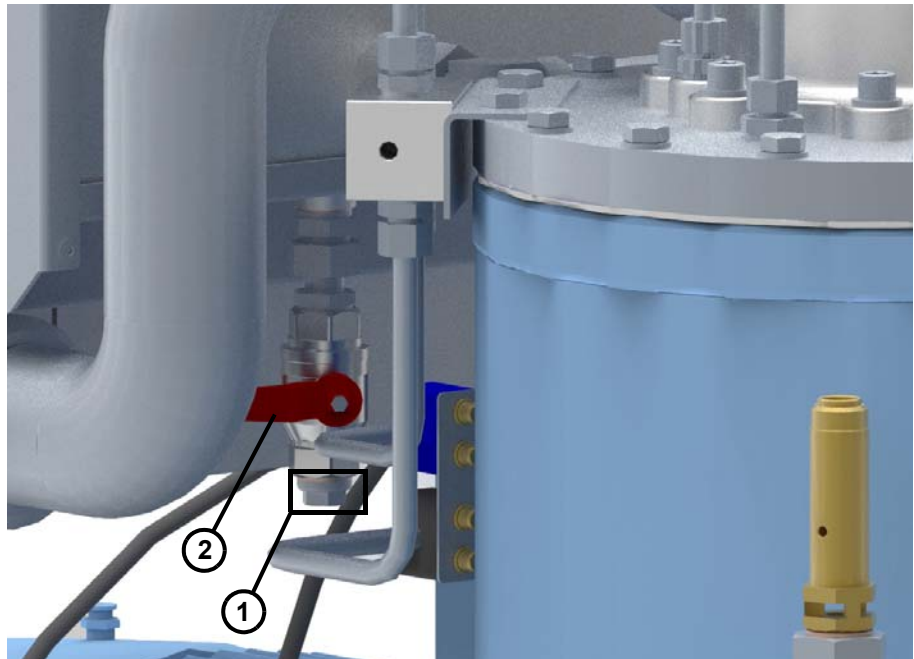

Fig. 6.13: Locking screw on the compressed air-oil cooler

15. Unscrew the locking screw (1) on the compressed air-oil cooler.
16. Remove and dispose of the copper sealing ring above the locking screw.
17. Open the ball valve (2) and drain the residual oil into the vessel.
18. When the oil stops flowing, close the ball valve (2).
19. Screw the locking screw (1) back in with a new copper sealing ring.

The residual oil in the compressor must be drained in a final step:

20. Remove the service side claddings so that the oil drain under the airend (see arrow in figure 6.14) is accessible.
21. Use a suitable vessel, e.g. oil sump, to catch the residual oil.

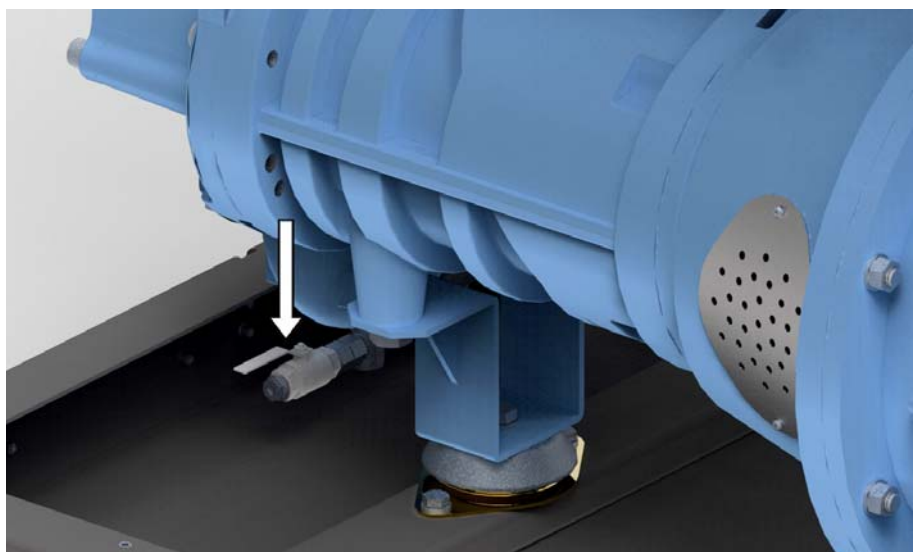

Fig. 6.14: Oil drain on the compressor

**CAUTION****Risk of scalds from hot oil!**

Contact with hot oil from the oil circuit may cause burns.

→ Wear PPE as well as protective goggles and gloves.

22. Remove the locking screw on the oil drain.
23. Remove and dispose of the copper sealing ring behind the locking screw.
24. Gradually open the ball valve and drain the residual oil into the vessel.
25. When the oil stops flowing, close the ball valve.
26. Screw the locking screw back into the oil drain with a new copper sealing ring.
  - The old oil has been completely removed from the system.
27. Unscrew the cap nut on the ventilation opening of the solenoid valve again (see also figure 6.11).
28. Dispose of the old oil properly.
29. Change the oil filter (see page 81).
30. Change the oil separator (see page 90).

**Adding new oil****Prerequisites for maintenance work:**

- The old oil has been completely drained.
- The compressor has been switched off using the OFF button.
- The compressor has been vented and the system pressure display shows 0 bar.
- The Emergency Stop button has been pressed, the mains disconnecting device has been opened (or the optional main switch has been pressed) and it has been secured with a padlock to prevent it from being accidentally switched on again.
- It has been checked that no voltage is present.
- The compressor has been disconnected from the compressed air network.

**ATTENTION****Compressor damage caused by improper servicing!**

Mixing different types or brands of oils in the oil circuit may damage or destroy the compressor.

→ Always use the same type of oil for refilling/topping up.

→ The oil circuit must be flushed before changing the type of oil (see "Flushing the oil circuit" on page 95 for more information).

To replenish new oil:

31. Remove the service side cladding so that the compressed air-oil receiver with oil filler neck (see arrow, figure 6.7) is accessible.
32. Unscrew the locking screw from the oil filler neck on the compressed air-oil container.
33. Fill the total oil fill quantity of oil for the relevant compressor type (see Technical data p. 25 ff.)
34. Screw the locking screw onto the oil filler neck on the compressed air-oil container.
35. Refit all service side claddings.

**ATTENTION****Risk of property damage!**

If the airend is operated without oil, components will be damaged.

→ After an oil change and before restarting the compressor, also add a small amount of oil to the suction regulator. Oil quantity and procedure see "Commissioning after a prolonged period of downtime: Adding oil" on page 59.

### Checking leak tightness and oil level.

To check the leak tightness and the oil level after the oil change:

36. If present, open the ball valve on the compressed air outlet.
37. Switch on the compressor and allow it to warm up to operating temperature.
38. Switch off the compressor.

**WARNING****Risk of injury from moving parts and overpressure!**

If the safety measures listed under the prerequisites for the maintenance work "Changing the filter element" have not been fully carried out, there is an increased risk of injury from moving or pressurised components of the machine.

→ All the above-mentioned prerequisites for the maintenance work "Changing the filter element", page 81, must be fulfilled prior to the inspection.

39. Remove the side cladding from the machine.
40. Check the oil filter for leaks (procedure as previously described).
41. If necessary, retighten components by hand (procedure as previously described).
42. Check the oil level on the oil level display (see also figure 6.6).
  - When the new oil level is between the "Min" (1) and "Max" (2) marks or at the "Max" mark, the oil circuit contains sufficient oil.
43. If necessary, top up the oil (procedure as previously described on page 76).

### Every 3,000/9,000 operating hours: Change oil separator

**Change interval:**

- For BOGE 3000plus and FoodLub-H1S compressor oils: after each oil change, i.e. every 3,000 operating hours, but no less than once a year.
- For Syprem S/SX compressor oil: after each oil change, i.e. every 9,000 operating hours, but no less than every two years.
- If the control outputs a message stating that the oil separator differential pressure is too high.

**CAUTION****Risk of injury due to fluids suddenly escaping!**

Defective oil separators may cause the differential pressure to rise to the point that the safety valve on the oil separation vessel is blown off.

→ Adhere to the stipulated servicing intervals.

**Changing the oil separator**

**Prerequisites for maintenance work:**

- The compressor has been switched off using the OFF button.
- The compressor has been vented and the system pressure display shows 0 bar.
- The Emergency Stop button has been pressed, the mains disconnecting device has been opened (or the optional main switch has been pressed) and it has been secured with a padlock to prevent it from being accidentally switched on again.
- It has been checked that no voltage is present.
- All hot components have cooled down.
- The compressor has been disconnected from the compressed air network.
- The oil has settled.

To change the oil separator:

	<p><b>CAUTION</b>  <b>Risk of scalds from hot oil!</b>                  Contact with hot oil from the oil circuit may cause burns.                  → Wear PPE as well as protective goggles and gloves.</p>
---	--

1. Remove the servicing side cladding and side cladding from the machine so that the compressed air-oil receiver is accessible from both sides (see figure below).



*Fig. 6.15: Removed claddings for changing the oil separator*

	<p><b>WARNING</b>  <b>Risk of injury due to overpressure!</b>                  If the compressor has not been completely vented, air under high pressure can escape from pipelines or individual components and cause severe injuries.                  → Ensure that the compressor has been completely vented.</p>
---	--

2. Completely unscrew the drainage pipe (1) (figure 6.16).
3. Completely unscrew the ventilation pipe (2) (figure 6.16).
4. Unscrew the flexible couplings (3+4) on the air pipe (figure 6.16).
5. Completely remove the section of the air pipe (5) (Figure 6.16).



For machines S 56-4 L to S 110-4 LF, the air pipe is designed as a single piece. Therefore the entire air pipe between the compressed air-oil receiver outlet and the cooler inlet, including their flexible couplings, must be removed.

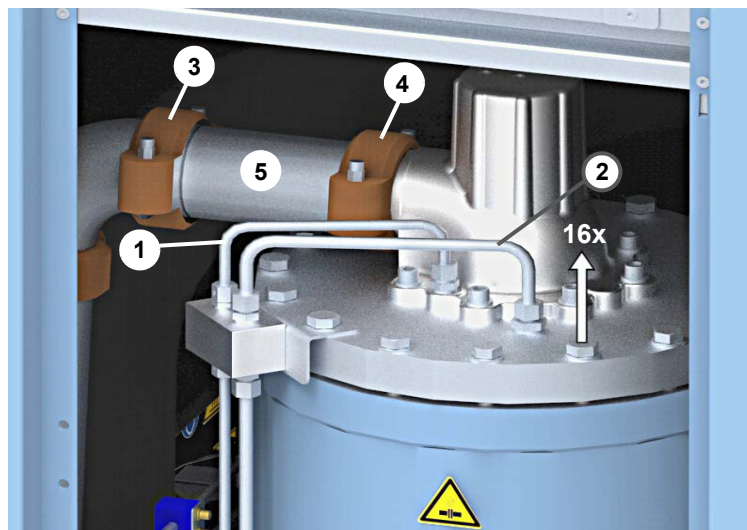

Fig. 6.16: Drainage pipe, ventilation pipe, air pipe and receiver screws

6. Unscrew all 16 screws on the compressed air-oil receiver lid (arrow in figure 6.16).
  - The figure below shows the result of the disassembly for machines S111-4 to S 160-4 LF:

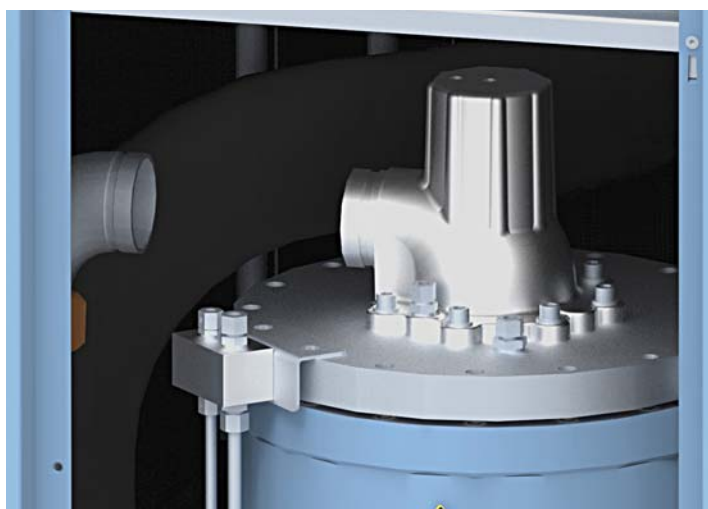

Fig. 6.17: Removed pipes, lines and screws

7. Screw in the lifting device screw on the compressed air-oil receiver (see arrow in Figure 6.18) and lift the lid of the compressed air-oil receiver by approx. 3 cm.



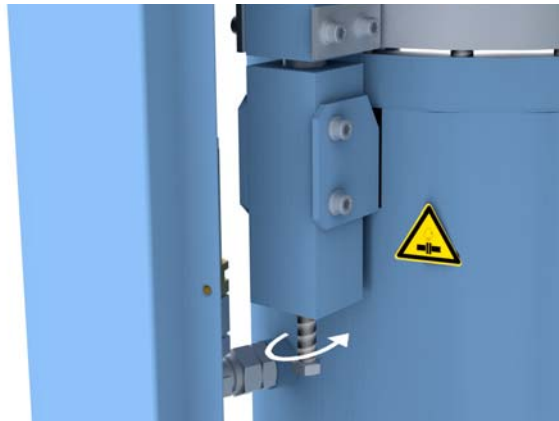

Fig. 6.18: Lift the lid using the lifting device

8. Swing the lid to one side (see figure 6.19).



Fig. 6.19: Opening the lid of the compressed air-oil filter

9. Lift the oil separator with seal and O-ring out of the open compressed air-oil receiver, see figure below.

10. Dispose of old components (oil separator, seal, O-ring) properly.

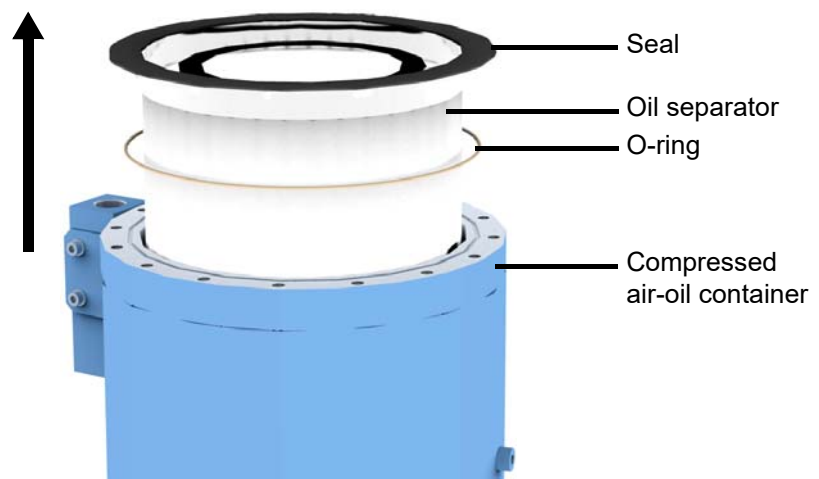



Fig. 6.20: Structure of the compressed air-oil container/integrated oil separator

11. Lightly oil the new O-ring.
12. Insert the new oil separator with new seal and new O-ring.
13. Swing the lid of the compressed air-oil receiver back into place.
14. Unscrew the lifting device screw on the compressed air-oil receiver until the lid sits flush with the compressed air-oil receiver again.
- 15a. Machines S 56-4 L to S 110-4 LF: Screw the 16 previously unscrewed screws into the compressed air-oil receiver lid with a tightening torque of **68 Nm**.
- 15b. Machines S 111-4 to S 160-4 LF: Screw the 16 previously unscrewed screws into the compressed air-oil receiver lid with a tightening torque of **106 Nm**.
16. Refit the air line with flexible couplings.
17. Refit the ventilation pipe.
18. Refit the drainage pipe.
19. Refit the service side claddings.

**Checking for leaks**

To check the system for leaks:

20. If present, open the ball valve on the compressed air outlet.
21. Switch on the compressor and allow it to warm up to operating temperature.

	<p><b>WARNING</b></p> <p><b>Risk of injury from moving parts and overpressure!</b></p> <p>If the safety measures listed under the prerequisites for the maintenance work “Changing the oil separator” have not been fully carried out, there is an increased risk of injury from moving or pressurised components of the machine.</p> <p>→ All the above-mentioned prerequisites for the maintenance work “Changing the oil separator” must be fulfilled prior to commencing work.</p>
---	--

22. Check the individual components that were removed and refitted during the maintenance work for leaks again by carrying out a visual inspection.
23. If necessary, retighten the screw connections.

**Every 3,000 operating hours: Function check of the safety valve**

A safety valve prevents inadmissible overpressure.

**Testing interval:**

- After approx. 3,000 operating hours but at least once a year.

	<p><b>WARNING</b></p> <p><b>Risk of injury from flying parts caused by overpressure, e.g. pressurised components bursting or exploding!</b></p> <p>A safety valve that has been removed or does not function properly means that the maximum permitted pressure in the compressor unit can no longer be limited. The uncontrolled pressure build up can cause severe injury to the operating and service personnel.</p> <p>→ The safety valve must not be removed or shut down.</p> <p>→ The specified final compression pressure must not be exceeded.</p> <p>→ Observe the statutory regulations applicable in the installation location for operating safety devices against overpressure.</p>
---	---



	<p><b>CAUTION</b>  <b>Risk of injury due to sudden discharge of hot compressed air!</b>  <b>Danger due to noise!</b></p> <p>If the maximum permitted pressure is exceeded (e.g. in the event of a fault or an incorrect setting), the entire free air delivery of the airend is blown off by the safety valve.</p> <p>➔ The compressor should only be operated with the housing closed.</p>
---	---

Have the function of the safety valve checked exclusively by BOGE Service personnel.

## 6.4 Performing special maintenance work

### Flushing the oil circuit

**It is necessary to flush the oil circuit with clean oil:**

- If the oil is heavily contaminated.
- Before changing the oil type.

	<p>Precise information on flushing when using BOGE oils can be obtained via the specified Technical Support number:  <b>Telephone: +49 5206 601-140</b></p>
---	---

### Manual relubrication system: Lubricate the drive motor bearings

The drive motor bearings must be relubricated with the specific quantity of grease suitable for each motor at the relubrication interval specified below. The specific quantity of grease must be calculated by the customer, as described below.

**Lubrication interval:**

- If the number of hours on the motor rating plate is 3,000 h or more:  
 After 3,000 operating hours but no less than once a year.
- If the number of hours on the motor rating plate is less than 3,000 h: When the machine is been in operation for the number of operating hours on the motor rating plate.

	<p>When the specified operating conditions are observed, the bearings do not require any maintenance between lubrication intervals.          Higher or lower thermal loads (due to a higher or lower coolant temperature) will reduce or extend the specified lubrication interval.</p>
---	---

**Calculating the quantity of lubricating grease:**

The rating plate of the drive motor is the basis for calculating the quantity of grease for relubricating the motor bearings.

Calculating the quantity of lubricating grease is explained using a motor rating plate as an example:

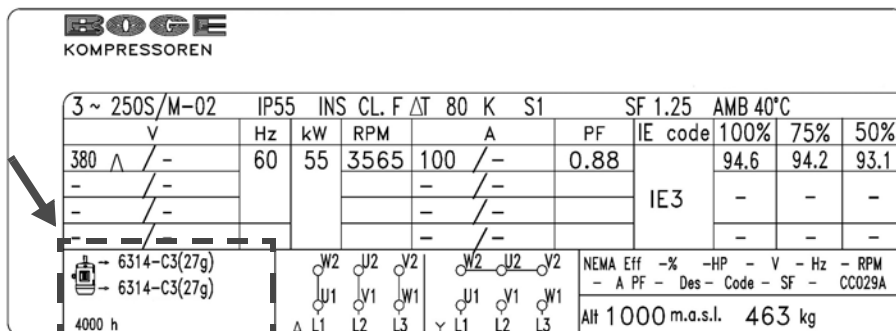

Fig. 6.21: Example of a motor rating plate

Every motor rating plate includes information on the type of grease, quantity of grease and the number of hours, as shown in the highlighted rectangle in the example.

Here:

- 2x 27 g (quantities of grease in grams for A and B sides)
- 4,000 h (relubricating interval in operating hours according to rating plate) <sup>1)</sup>

The quantity of grease that must be used to relubricate the A and B sides of the motor can be calculated based on these values using the formula below:

$$\text{Quantity of grease for relubrication [g]} = \frac{\text{Quantity of grease [g]}}{\text{Relubrication interval [h]}} \times 3,000 \text{ [OH]}$$

For the example motor rating plate shown above, this works out as:

$$\text{Quantity of grease for relubrication [g]} = \frac{27 \text{ [g]}}{4,000 \text{ [h]}} \times 3,000 \text{ [OH]}$$

The result is 20.25, rounded to **20 grams**.

➔ According to this example motor rating plate, 20 grams of grease must be pressed into the A side and 20 grams of grease into the B side of the motor.

<sup>1)</sup> If the relubrication interval on the rating plate is < 3,000 h, the lubrication interval does not need to be calculated. The specified lubricant quantity must be relubricated at the interval that appears on the rating plate.

	<p><b>WARNING</b></p> <p><b>Risk of injury from moving parts and overpressure!</b></p> <p>To read the information on the rating plate of the drive motor, the machine must be open. If the following prerequisites have not been met prior to this, there is an increased risk of injury from moving or pressurised components of the machine.</p> <p>➔ Before reading the information on the rating plate of the drive motor, the following prerequisites must be met:</p> <ul style="list-style-type: none"> <li>– The compressor has been switched off using the OFF button.</li> <li>– The compressor has been vented and the system pressure display shows 0 bar.</li> <li>– The Emergency Stop button has been pressed, the mains disconnecting device has been opened (or the optional main switch has been pressed) and it has been secured with a padlock to prevent it from being accidentally switched on again.</li> <li>– It has been checked that no voltage is present.</li> <li>– All hot components have cooled down.</li> </ul>
---	---

### Lubricating the bearings

#### Prerequisites for maintenance work:

- The compressor is in idle-run or load-run.

To lubricate the drive motor bearings:

1. Use a grease gun to apply lubricating grease to the grease nipples on the relubrication system (position indicated by the arrow in the figure below).

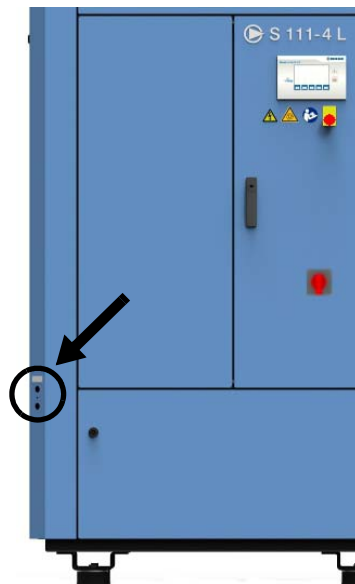

Fig. 6.22: Manual relubrication system: position of the grease nipples

**ATTENTION****Risk of property damage!**

Incorrect lubrication of the motor bearings will cause damage to the compressor.

- ➔ Lubricate the drive motor bearings on a regular basis at the specified interval.

**ATTENTION****Risk of property damage!**

The use of unsuitable lubricants may give rise to malfunctions and serious property damage.

- ➔ Always use the same type of grease for lubrication. If different types of grease are mixed, their lubrication capacity may be significantly reduced.
- ➔ Excess greasing or a surplus of lubricant may also result in destruction of the bearings.

If another type of grease is to be used:

- ➔ Arrange for BOGE service to dismantle the bearings and thoroughly clean them prior to refilling.
- ➔ It is vital that the specified relubrication intervals and calculated grease quantities are observed.

2. Using the grease gun, inject the calculated quantity of grease through the nipple into the bearings on the A side of the motor.
3. Using the grease gun, inject the calculated quantity of grease through the nipple into the bearings on the B side of the motor.

### **Automatic relubrication system (optional): Change grease cartridges**

The automatic relubrication system is available as an option on all machines.

**Change interval:**

- When the control outputs the corresponding message.

The automatic relubrication system is installed inside the compressor housing. It is operated and monitored automatically by the control. All the important default settings are therefore applied at the factory. However, the grease cartridges must be changed regularly.

### **Changing the cartridge**

**Prerequisites for maintenance work:**

- The compressor has been switched off using the OFF button.
- The compressor has been vented and the system pressure display shows 0 bar.
- The Emergency Stop button has been pressed, the mains disconnecting device has been opened (or the optional main switch has been pressed) and it has been secured with a padlock to prevent it from being accidentally switched on again.
- It has been checked that no voltage is present.
- All hot components have cooled down.
- The compressor has been disconnected from the compressed air network.

To change an empty grease cartridge:

1. Remove the service side cladding so that the automatic relubrication system is accessible (see figure below).

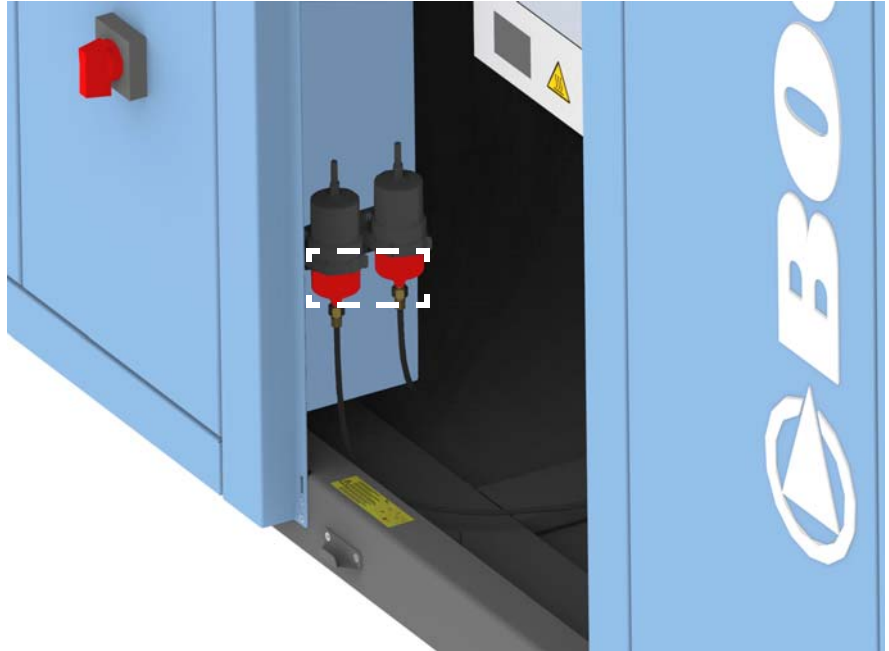

Fig. 6.23: Autom. relubrication system: position of the grease cartridges



**ATTENTION**

**Risk of property damage!**

Incorrect lubrication of the motor bearings will cause damage to the compressor.

→ Change cartridges as soon as the control outputs a message to this effect.

2. Undo the connections on the relubrication system with empty grease cartridges leading to the motor and control.
3. Undo the union joint on the relubrication system (see figure 6.24, step 1, diagram 1).

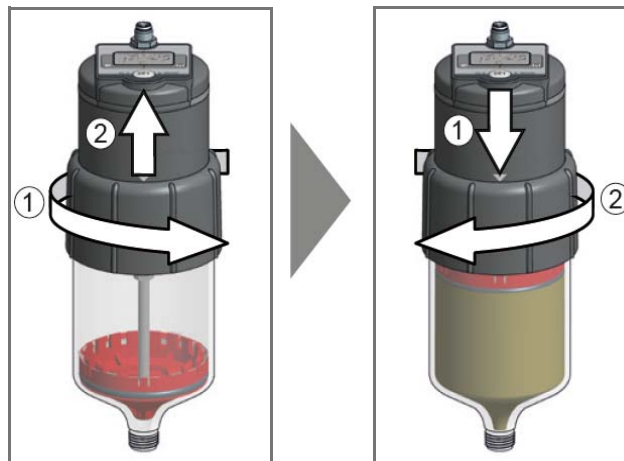

Diagram 1

Diagram 2

Fig. 6.24: Changing the grease cartridge

4. Remove the old cartridge (see figure 6.24, step 2, diagram 1).

**ATTENTION****Risk of property damage!**

The use of unsuitable lubricants may give rise to malfunctions and serious property damage.

- ➔ Always use the same type of grease for lubrication. If different types of grease are mixed, their lubrication capacity may be significantly reduced.
- ➔ Excess greasing or a surplus of lubricant may also result in destruction of the bearings.

If another type of grease is to be used:

- ➔ Arrange for BOGE service to dismantle the bearings and thoroughly clean them prior to refilling.
- ➔ It is vital that the specified relubrication intervals and grease quantities are observed.

5. Fit the automatic relubrication system to the new cartridge (see figure 6.24, step 1, diagram 2).
6. Fit the union joint to the relubrication system (see figure 6.24, step 2, diagram 2).
7. Restore the connections to the motor and control.
8. Refit the service side cladding.

### Having the drive motor bearings replaced

**Exchange interval:**

- For directly coupled machines and machines with transmission drive:  
After 40,000 operating hours.
- For frequency-controlled machines S-4 LF: After 20,000 operating hours.

**ATTENTION****Risk of property damage!**



Unqualified personnel exchanging the bearings of the drive motor can result in compressor damage.

- ➔ Only have bearings of the drive motor replaced by BOGE service personnel.



Increased or less thermal stress (due to increased or reduced coolant temperature) reduces or lengthens the number of operating hours, after which the bearings must be replaced.

### 6.5 Dismantling and disposal of replaced parts

	<p><b>DANGER</b>  <b>Danger of death due to electric current!</b>                  Coming into contact with live parts, defective insulation or components can be fatal.</p> <ul style="list-style-type: none"> <li>→ All work on the electrical system must only be carried out by authorised electricians.</li> <li>→ Before starting work, the connection cable from the mains to the switch cabinet must be disconnected and secured to prevent it from being switched on again.</li> </ul>
	<p><b>WARNING</b>  <b>Risk of injury due to sharp edges, hot surfaces, overpressure and hazardous substances!</b></p> <p>If components or hazardous substances are dismantled and disposed of by unauthorised or unqualified personnel, this may lead to serious accidents due to inadequate specialist knowledge.</p> <ul style="list-style-type: none"> <li>→ Dismantling and disposal should only be carried out by duly authorised and qualified personnel.</li> <li>→ Wear PPE.</li> </ul>
	<p>Dispose of all system parts in such a way that damage to health and the environment is avoided.</p>

The following electronic components must always be disposed of separately:

- Displays, display devices
- Electrical power supply
- Controls
- Circuit boards with electronic components

Hazardous substances such as lubricants and contaminated components, if applicable, must also be disposed of separately.

	<p>The WEEE Regulations are in line with BOGE's applicable General Terms and Conditions in their current respective versions.</p> <p>Should you have any queries, please contact Technical Support on:  <b>Telephone: +49 5206 601-140</b></p>
---	--

## 6.6 Spare parts and additional equipment

### List of wearing parts (for servicing)

Name
Set of filter mats for supply air filter
Compressor oils 3000plus/FoodLub-H1 S/Syprem S/Syprem SX
Lubricating grease for drive motor bearings
cairpac 3,000: Complete maintenance package for maintenance every 3,000 operating hours: Oil filter, oil separator, suction filter cartridge, seals, minimum pressure valve (set of wearing parts), oil regulator (set of wearing parts)
cairpac +9,000: Complete maintenance package for maintenance every 9,000 operating hours: – cairpac 3,000 components – Suction regulator wearing parts set – Solenoid valve set of wearing parts

### List of available additional equipment





Name
Additional equipment for treating compressed air
Oil-water separator
Cyclone separator
Automatic condensate drain
Automatic relubrication fitting for motor bearings (optional)
BOGE-DUOTHERM BPT Plate heat exchanger



## 7.1 Basic information on remedying faults

The table on the following page provides information on the possible causes of operating faults and measures for their rectification (please also refer to the operating instructions for the compressor control).

### Safety prior to commencing work

	<p><b>DANGER</b>  <b>Danger of death due to electric current!</b>          Coming into contact with live parts, defective insulation or components can be fatal.          Prior to any work required to remedy faults:          → Open the mains disconnecting device (or press the optional main switch) and use a padlock to prevent it from being accidentally switched on again.</p>
	<p><b>WARNING</b>  <b>Risk of injury from moving parts, hot surfaces or overpressure!</b>          If fault and problem rectification (incl. maintenance and repair work) is carried out by unauthorised or unqualified personnel, this may lead to serious accidents due to inadequate specialist knowledge.          → Faults and problems may only be rectified by authorised and qualified personnel or BOGE Service personnel.          → Ensure that components that have a safety function are only set, repaired or exchanged by BOGE Service personnel.          → If in doubt, please contact Technical Support.          → Wear PPE, e.g. protective gloves, respiratory protection.</p>
	<p><b>ATTENTION</b>  <b>Compressor damage due to incorrectly performed work!</b>          If fault and problem rectification (incl. maintenance and repair work) is carried out by unauthorised or unqualified personnel, this can damage or destroy the compressor.          → Faults and problems may only be rectified by authorised and qualified personnel or BOGE Service personnel.          → If in doubt, please contact Technical Support.</p>
	<p>Should you have any questions about this product, please contact Technical Support on:  <b>Telephone: +49 5206 601-140</b>            If you require Service assistance, please contact BOGE Service on:  <b>Telephone: +49 5206 601-100</b></p>

**Compressor faults**

The information provided in the following table relates to the compressor system.

Fault	Possible cause	Rectification
No free air delivery, no pressure build-up, maximum pressure 0.5 bar	System components in the compressor are leaking	Check oil and compressed air pipes inside the compressor; retighten or reseal screw connections if necessary
	Minimum pressure valve defective	If present, close ball valve and check whether pressure is building up; if this is the case, reopen the ball valve immediately and replace the minimum pressure valve
	Electromagnetic venting valve not closing	Check solenoid valve and replace if necessary
	Suction regulator not opening	Suction regulator or solenoid valve defective; check and replace if necessary
Compressor system does not start	No power to compressor	Check electrical connection
	Fuses are faulty	Check mains and control fuses and replace if necessary
	System has not been completely ventilated	Check venting valve and replace if necessary
	Power fluctuations in the electrical supply network	Ensure there is constant voltage in accordance with IEC 38
	Compressor oil is extremely viscous as ambient temperature is too low	Warm up compressor system (auxiliary heating available on request)
Oil in suction filter	Minimum pressure non-return valve leaking	Check minimum pressure non-return valve and replace if necessary
	Suction regulator leaking	Check suction regulator and replace if necessary
Oil consumption too high	Drainage line blocked	Remove and clean drainage line
	Oil separator element defective	Check oil separator and replace if necessary
	Compressor filled with too much oil	Drain oil
Safety valve blows off	Operating pressure setpoint has changed	Set operating pressure to the maximum permitted pressure of the screw compressor
	Safety valve is faulty	Replace safety valve
System pressure is not reduced when system switched off	Venting valve not opening	Check venting valve and replace if necessary
	Non-return valve leaking	Check non-return valve and replace if necessary

Table 7.1: List of possible faults

## 8.1 Guidelines and standards

The compressor conforms to the following guidelines and standards:

### Guidelines and directives

- Machinery Directive 2006/42/EC
- Pressure Equipment Directive 2014/68/EU
- EMC Directive 2014/30/EU
- Low Voltage Directive 2014/35/EU
- Simple Pressure Vessels Directive 2014/29/EU

### Applied harmonised standards

- EN 1012-1
- EN ISO 12100
- EN 60204-1 / VDE 0113-1
- EN 61000-6-2 / VDE 0839-6-2
- EN 61000-6-4 / VDE 0839-6-4

## 8.2 Application of the Pressure Equipment Directive

This section covers the application of the Pressure Equipment Directive (PED) 2014/68/EU to the specified compressor series and their pressurised components.

### Scope

Screw compressors with transmission drive:

- S 76-4 (7.5 bar, 10 bar, 13 bar)
- S 90-4 (7.5 bar, 10 bar, 13 bar)
- S 110-4 (10 bar, 13 bar)
- S 111-4 (7.5 bar, 10 bar, 13 bar)
- S 132-4 (7.5 bar, 10 bar, 13 bar)
- S 160-4 (7.5 bar, 10 bar, 13 bar)

Directly coupled screw compressors:

- S 56-4 L (7.5 bar)
- S 110-4 L (7.5 bar)
- S 111-4 L (7.5 bar)
- S 132-4 L (10 bar)
- S 160-4 L (13 bar)
- S 56-4 LF (7.5 bar, 10 bar, 13 bar)
- S 76-4 LF (7.5 bar, 10 bar, 13 bar)
- S 90-4 LF (7.5 bar, 10 bar, 13 bar)
- S 110-4 LF (7.5 bar, 10 bar, 13 bar)
- S 111-4 LF (7.5 bar, 10 bar, 13 bar)
- S 132-4 LF (7.5 bar, 10 bar, 13 bar)
- S 160-4 LF (7.5 bar, 10 bar, 13 bar)

## Classification and assessment of pressurised components

Compressor/compressed air systems and compressor stations are assemblies according to the PED. The classification of an assembly according to the PED is based on the highest category of the individual components.

Compressor components	Pressure volume product $P_s \cdot V$ (max.) Pressure nominal width product $P_s \cdot DN$ (max.)	Classification/assessment according to PED	Conformity assessment procedure to be applied according to directive...
Pipelines (Compressed air pipe system, hoses)	$P_s \cdot DN \leq 3,500$	Cat. I	PED
Safety equipment (safety valves)	n.a.	Category IV in accordance with Article 2.4 (not considered for assembly assessment)	PED
Oil separation vessel	$P_s \cdot V > 3,000$	Excluded from scope in accordance with Article 1.2.c)	Simple Pressure Vessels Directive 2014/29/EU
Compressor/compressor block	n.a.	Excluded from scope in accordance with Article 1.2.j)	Machinery Directive
Pressure retention valve MDV	$P_s \cdot V \leq 50$	Article 4.3	PED
Air cooler S 56-4 L...S 110-4 LF	$P_s \cdot V \leq 200$	Cat. I	PED
Air cooler S 111-4...S 160-4 LF	$P_s \cdot V \leq 1,000$	Cat. II	
Oil cooler	$P_s \cdot V \leq 10,000$	Article 4.3	PED
Plate heat exchanger for water cooling (optional), air side	$P_s \cdot V \leq 200$	Cat. I	PED
Plate heat exchanger for heat recovery (optional)	$P_s \cdot V \leq 10,000$	Article 4.3	PED
Supplementary equipment belonging to the assembly (e.g. filter, cyclone separator, condensate drain)	$P_s \cdot V \leq 50$ $P_s \cdot DN \leq 1,000$	Article 4.3	PED

## Outcome of the assessment

Every aspect of the assembly of the pressurised compressor components mentioned above is affected by the scope of the Pressure Equipment Directive (PED).

Applied conformity evaluation procedure in line with the PED:

- S 56-4 L...S 110-4 LF: Module A
- S 111-4...S 160-4 LF: Module D1.

## Installation in compressed air systems

Installation of the above assemblies in a compressed air system gives rise, where applicable, to the creation of a new assembly within the meaning of the PED.

## 8.3 Piping and instrumentation flow chart

The following pages contain the individual piping and instrumentation flow charts for the different machine types.







101 Intake air INLET (+5...+46°C/1 bar 0...90% rel. humidity)

102 Compressed air OUTLET

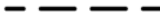
- |  |  |
|--|--|
| 1 Supply air filter mat                                    | 22 Oil separation vessel drain                                       |
| 2 Suction filter   | 23 Minimum pressure non-return valve                                 |
| 3 Suction filter monitoring *                              | 24 Compressed air/air heat exchanger<br>(compressed air aftercooler) |
| 4 Suction hose   | 25 Radial fan  |
| 5 Suction regulator  | 26 Fan motor   |
| 6 Venting valve  | 27 Fan motor overcurrent switch                                      |
| 7 Quick-start valve *                                      | 28 Frequency converter *   |
| 8 Suction regulator control valve                          | 29 Net pressure monitoring   |
| 9 Airend   | 30 Cyclone separator *   |
| 10 Final compression temperature<br>measuring point        | 31 Condensate drain *  |
| 11 Coupling  | 32 Thermostatic oil control valve                                    |
| 12 Drive motor   | 33 Oil/air heat exchanger (oil cooler)                               |
| 13 Drive motor temperature monitoring                      | 34 Oil filter  |
| 14 Drive motor bearing temperature *                       | 35 Oil filter monitoring *   |
| 15 Lubricator *  | 36 Drainage line   |
| 16 Drain   | 37 Non-return valve  |
| 17 System pressure monitoring                              | 38 BPT oil/water heat exchanger *                                    |
| 18 Oil separation vessel (compressed<br>air-oil container) | 39 BPT temperature control valve *                                   |
| 19 Compressed air safety valve                             | 40 Refrigeration dryer *   |
| 20 Oil separation element (oil separator)                  | 41 Condensate drain *  |
| 21 Oil level monitoring                                    |  |

\* Option

	Compressed air
	Oil
	Condensate
	Grease
	Cooling water
	Dashed line

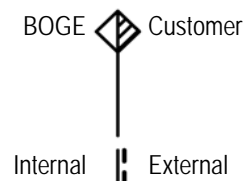









101 Intake air INLET (+5...+46°C/1 bar 0...90% rel. humidity)

102 Compressed air OUTLET

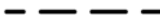
- |  |  |
|--|--|
| 1 Supply air filter mat                                    | 23 Minimum pressure non-return valve                                   |
| 2 Suction filter   | 24 Compressed air/water heat exchanger<br>(compressed air aftercooler) |
| 3 Suction filter monitoring *                              | 25 Axial fan   |
| 4 Suction hose   | 26 Fan motor   |
| 5 Suction regulator  | 27 Fan motor overcurrent switch  |
| 6 Venting valve  | 28 Frequency converter *   |
| 7 Quick-start valve *                                      | 29 Net pressure monitoring   |
| 8 Suction regulator control valve                          | 30 Cyclone separator *   |
| 9 Airend   | 31 Condensate drain *  |
| 10 Final compression temperature<br>measuring point        | 32 Thermostatic oil control valve                                      |
| 11 Coupling  | 33 Oil/water heat exchanger (oil cooler)                               |
| 12 Drive motor   | 34 Oil filter  |
| 13 Drive motor temperature monitoring                      | 35 Oil filter monitoring *   |
| 14 Drive motor bearing temperature *                       | 36 Drainage line   |
| 15 Lubricator *  | 37 Non-return valve  |
| 16 Drain   | 38 BPT oil/water heat exchanger *                                      |
| 17 System pressure monitoring                              | 39 BPT temperature control valve *                                     |
| 18 Oil separation vessel (compressed<br>air-oil container) | 40 Refrigeration dryer *   |
| 19 Compressed air safety valve                             | 41 Condensate drain *  |
| 20 Oil separation element (oil separator)                  | 42 Cooling water solenoid valve  |
| 21 Oil level monitoring                                    |  |
| 22 Oil separation vessel drain                             |  |

\* Option

	Compressed air
	Oil
	Condensate
	Grease
	Cooling water
	Dashed line

